

Modelarstwo papierowe

## **SOLARPTAK**

Wielkość – 800 x 300 x 350mm

Materiał: 19 arkuszy papieru A4



**HORIZON**  
II  
FORBIDDEN WEST™

Produkt został zaprojektowany przez Trunk Cultural & Creative Co., LTD.

---

©2022 Sony Interactive Entertainment Europe. Wyprodukowane przez Guerilla.  
Horizon Forbidden West jest znakiem handlowym Sony Interactive Entertainment LLC.



## Zalecany jest papier do drukowania

Oficjalny, ukończony produkt wydrukowany jest na papierze ok. 235 gsm.  
Prosimy o drukowanie na papierze A4 od 160-180 gsm lub grubszym.  
Podczas drukowania, wybierz drukowanie dwustronne, zaginanie wzdłuż dłuższego  
boku i wydruk kolorowy.

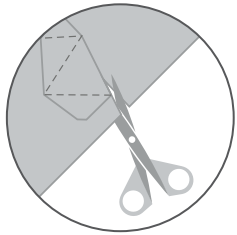

1. Wytnij kształty wzdłuż linii ciągłych.

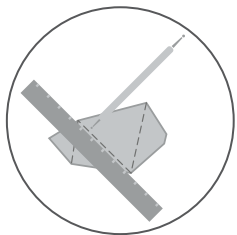

2. Użyj pióra do zaginania (lub tępej krawędzi noża)  
i wykonaj zagięcia wzdłuż linii kropkowanych.

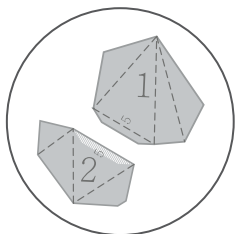
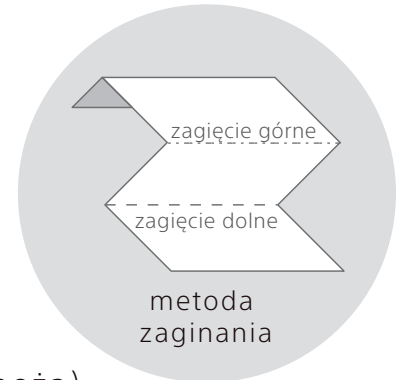

3. Wklej lub umieść elementy w porządku numerycznym  
(duże liczby), a następnie dopasuj małe liczby i doklej  
klapki (nie trzeba robić tego w porządku numerycznym).

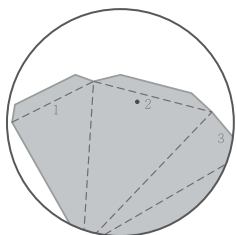

4. Zaczynaj kleić od kłapek oznaczonych „.", aby wykonywać  
kolejne ruchy.

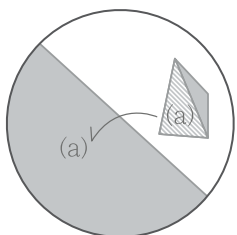

5. Po złożeniu dodatkowych części, dopasuj numery części  
do tych samych numerów na głównym korpusie. Następnie  
doklej je lub włóż.



' R = right side  
' L = left side

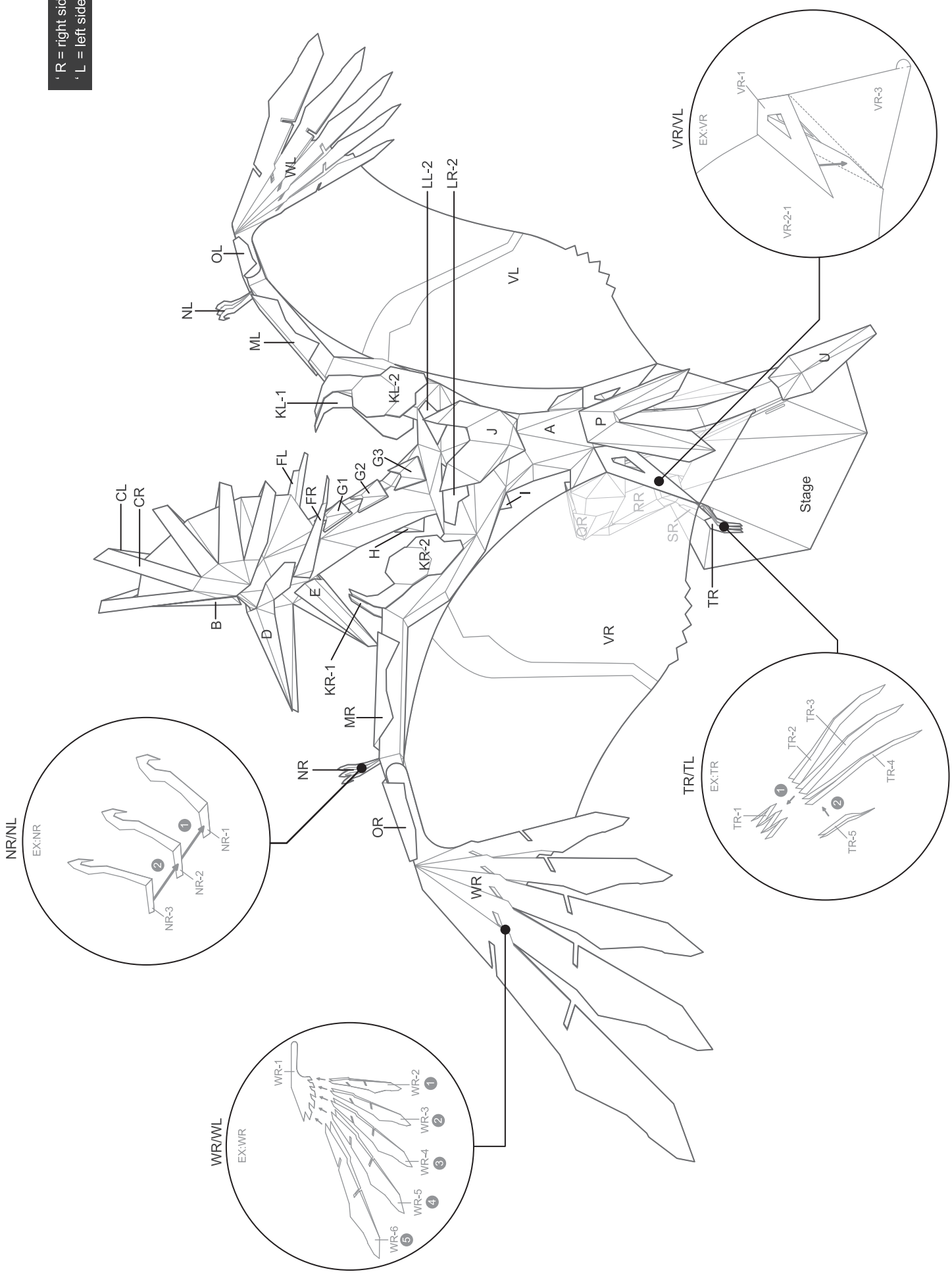



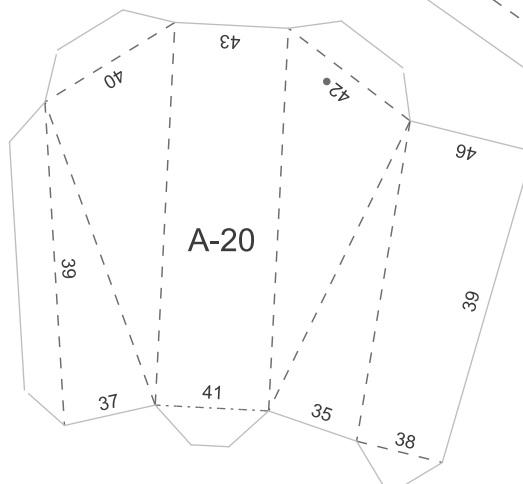
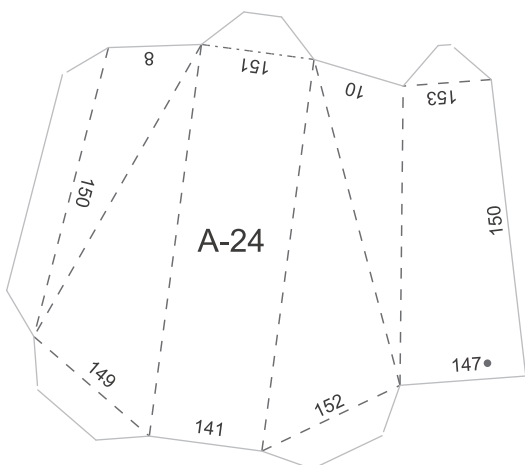
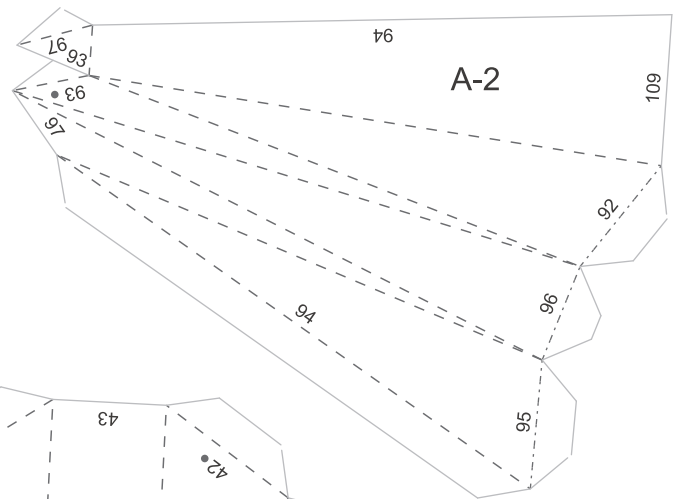
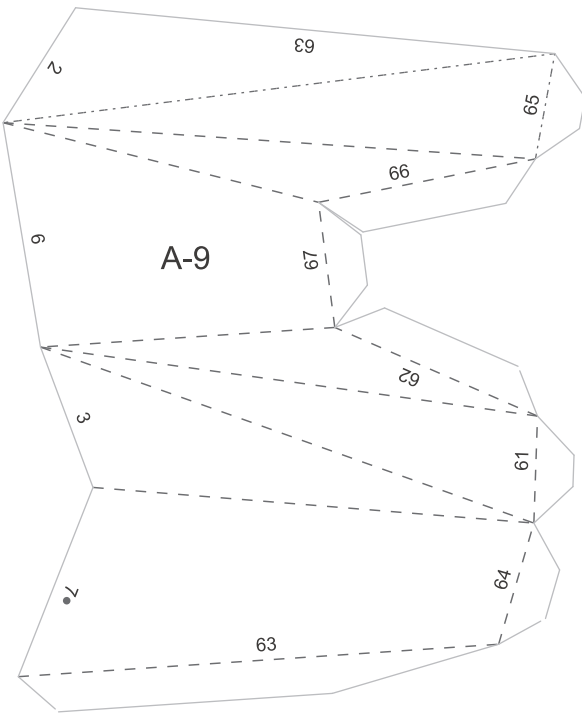
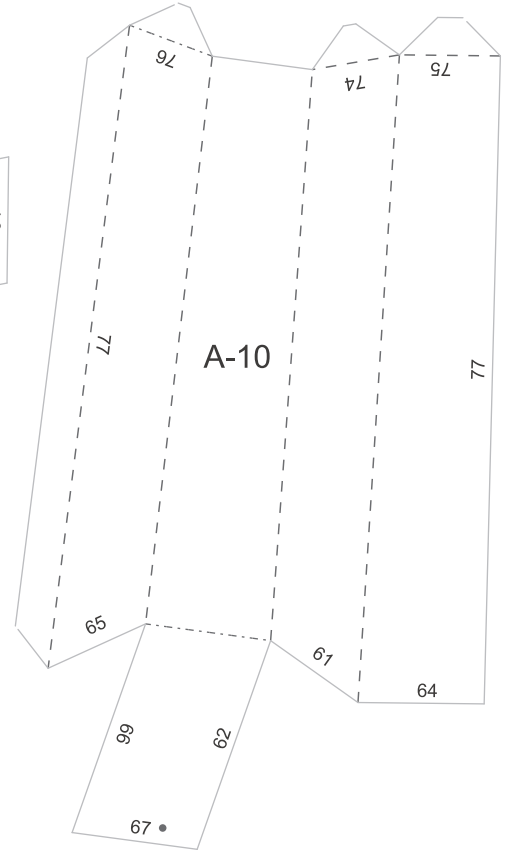
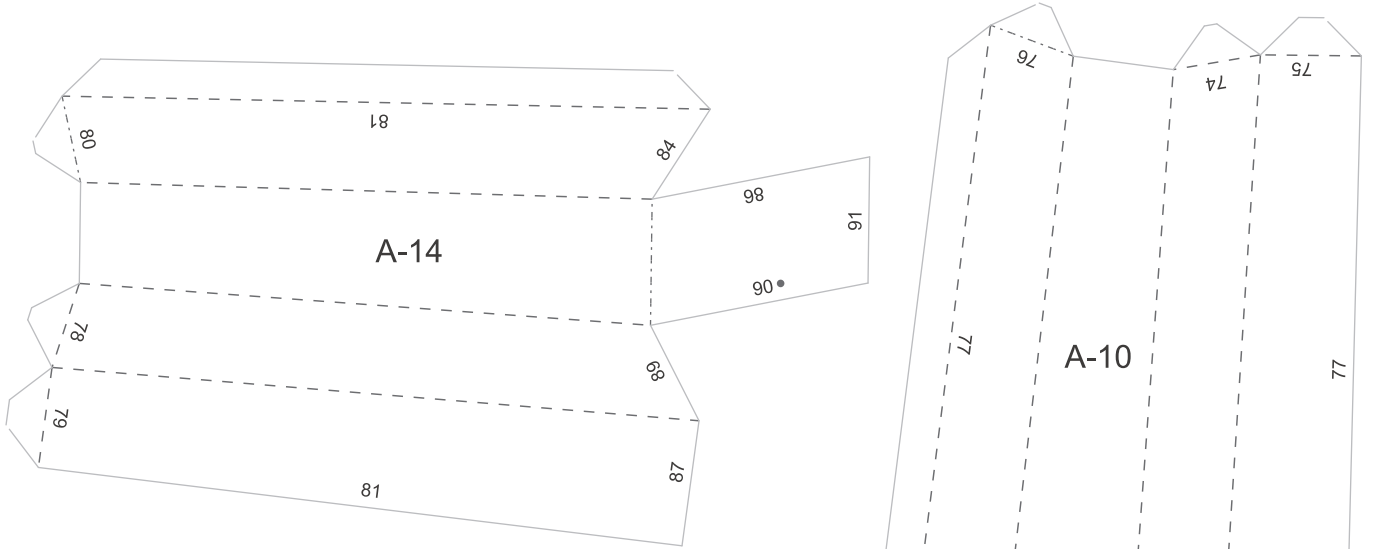
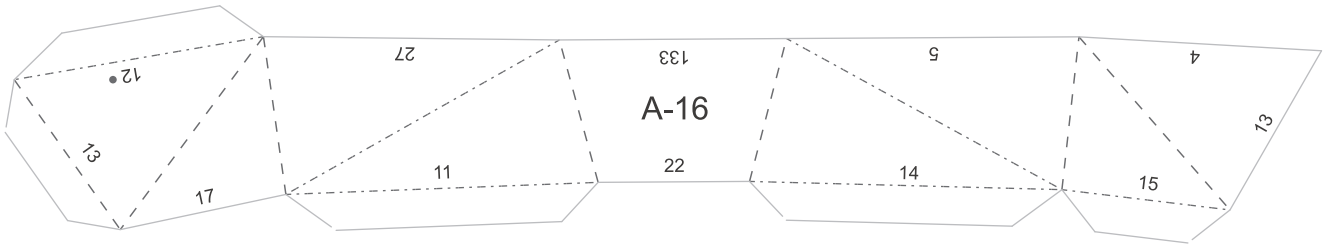

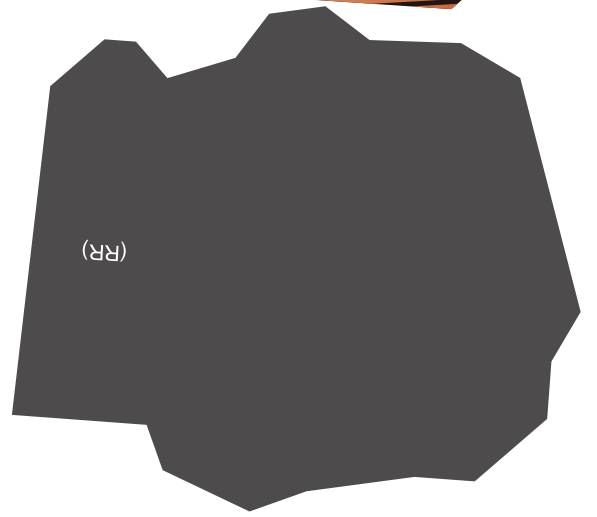
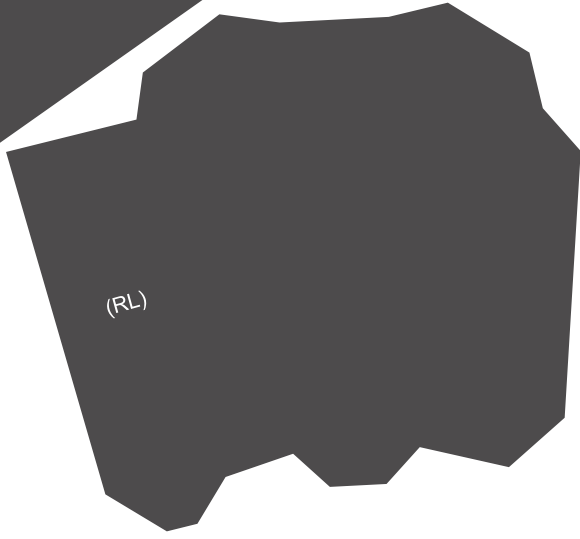
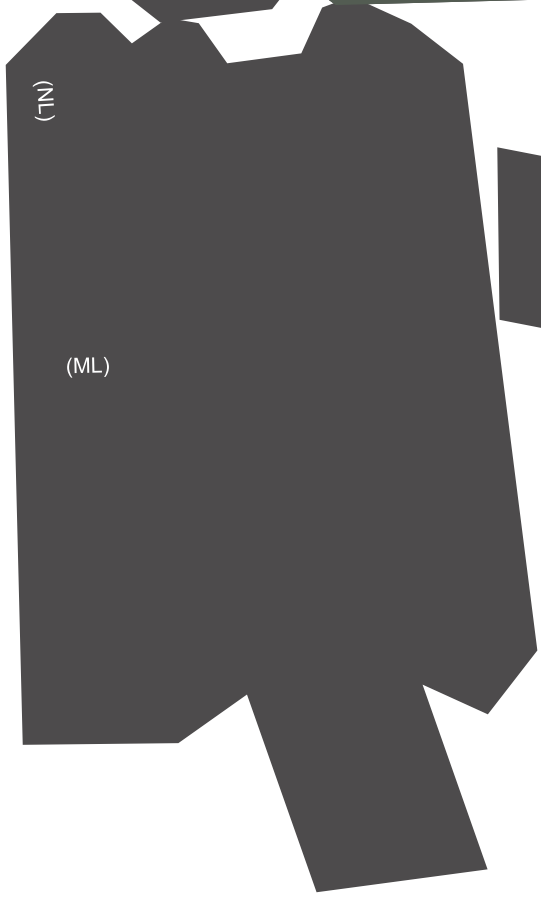
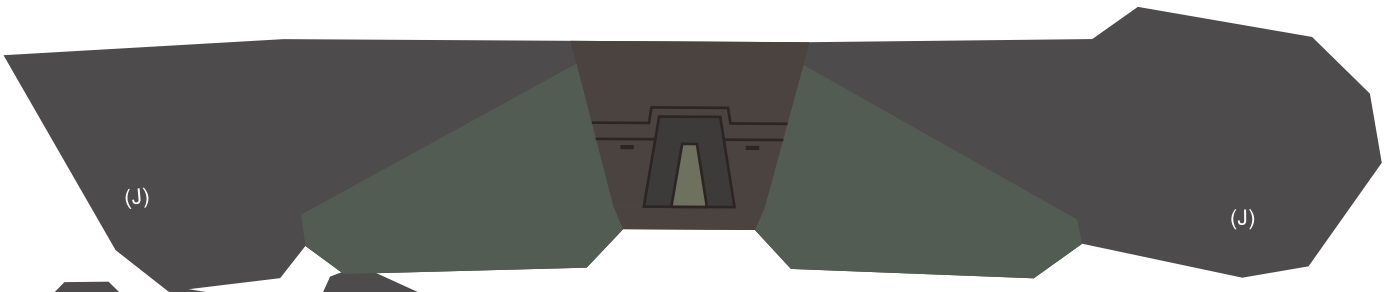



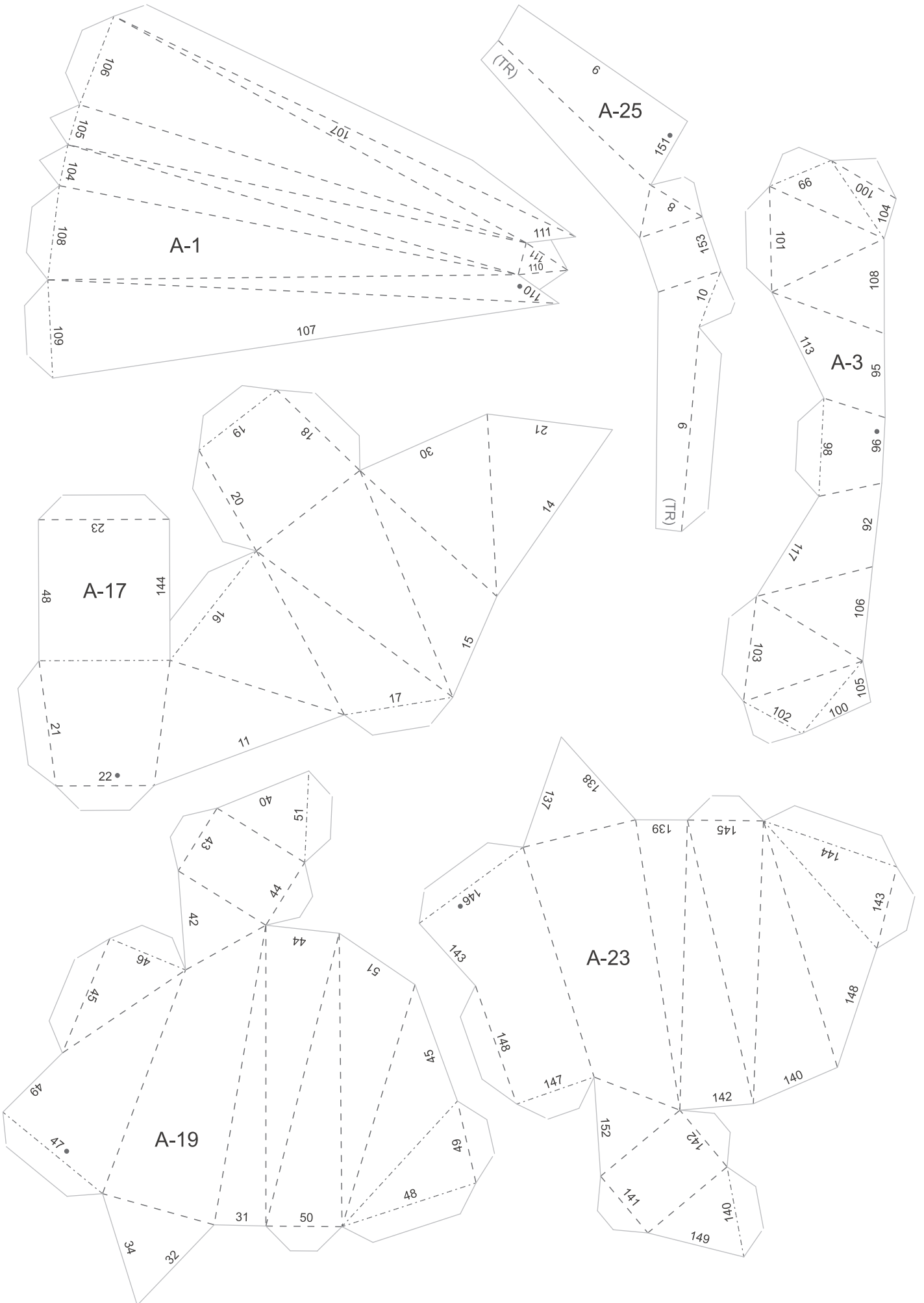

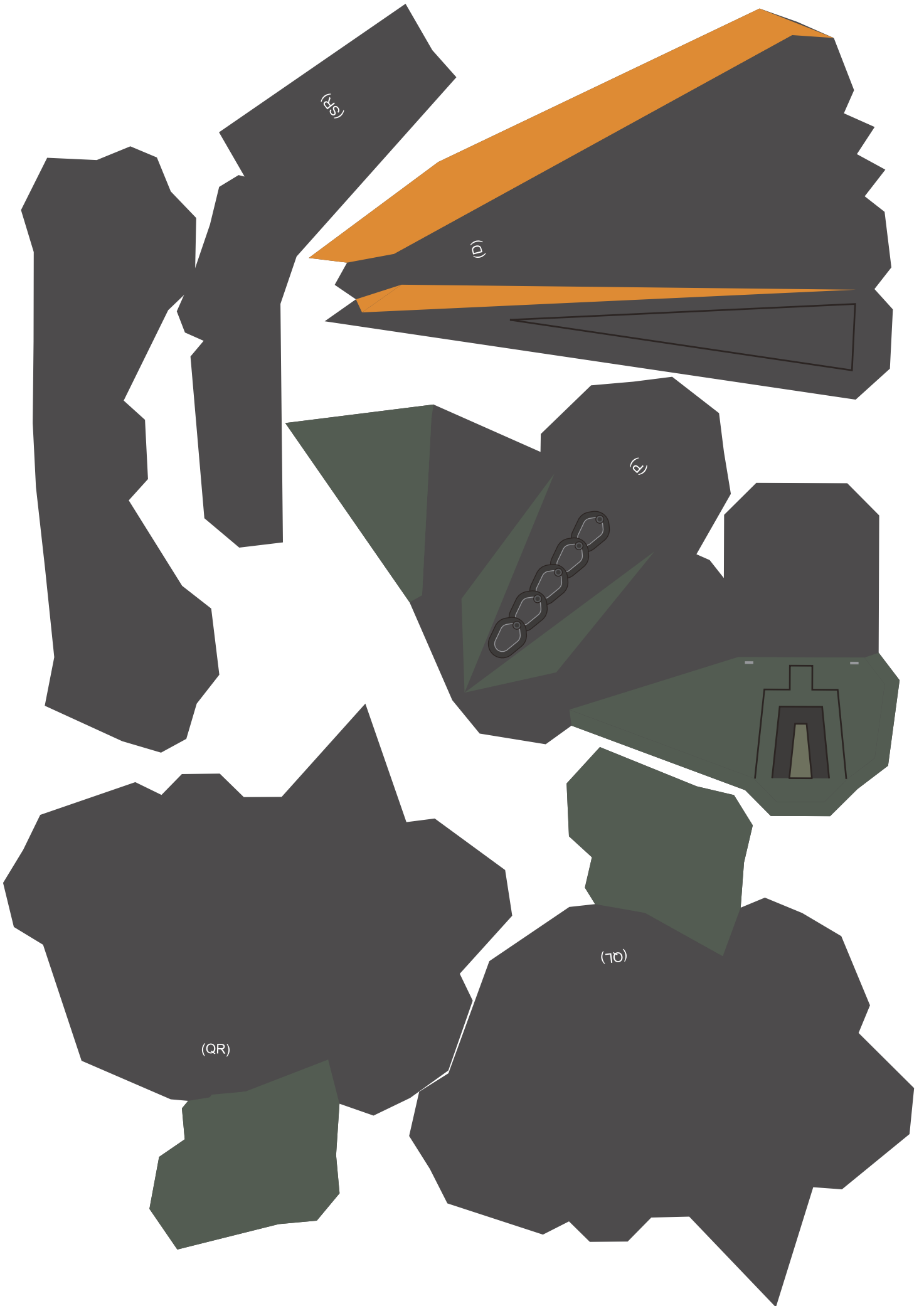

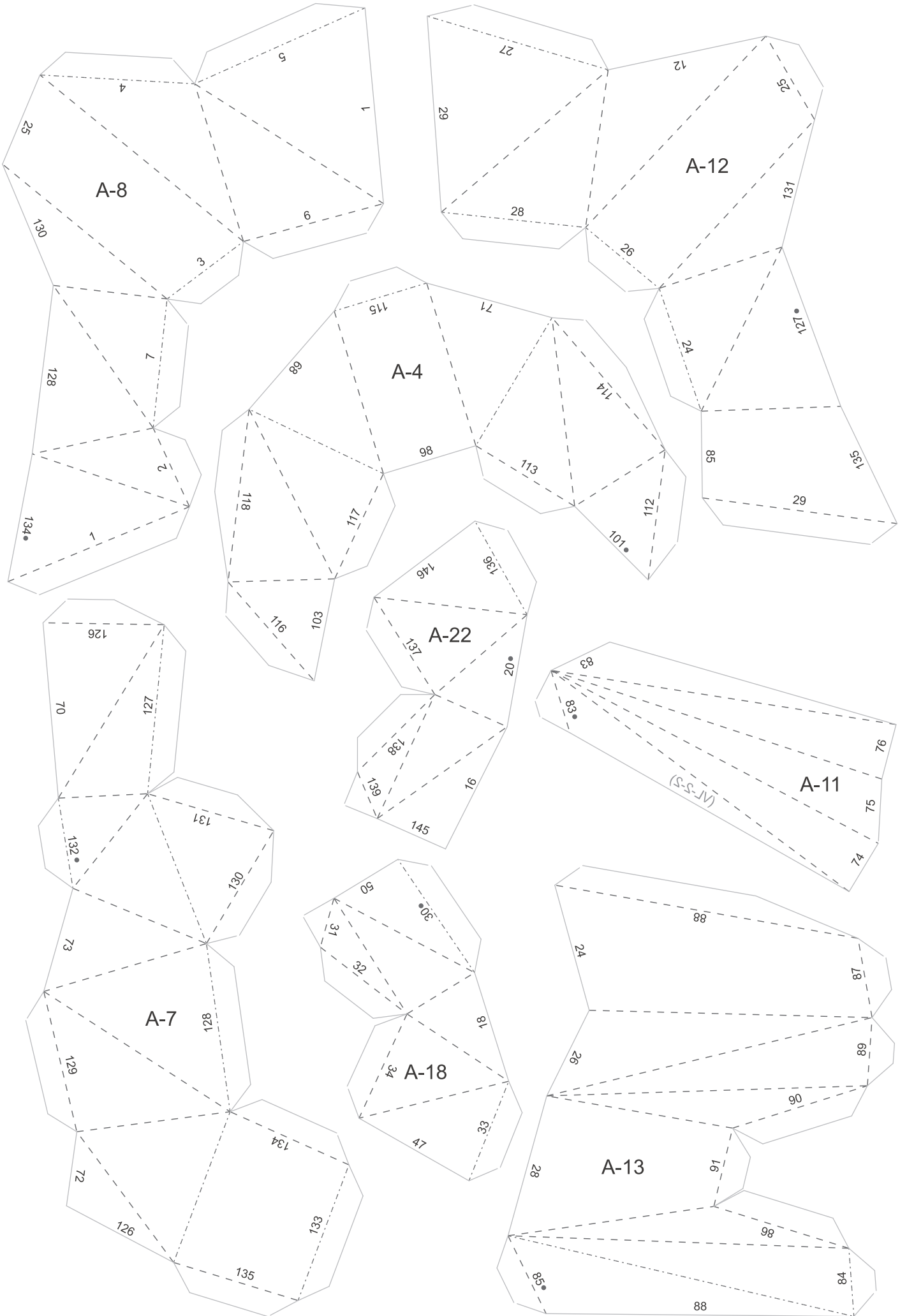

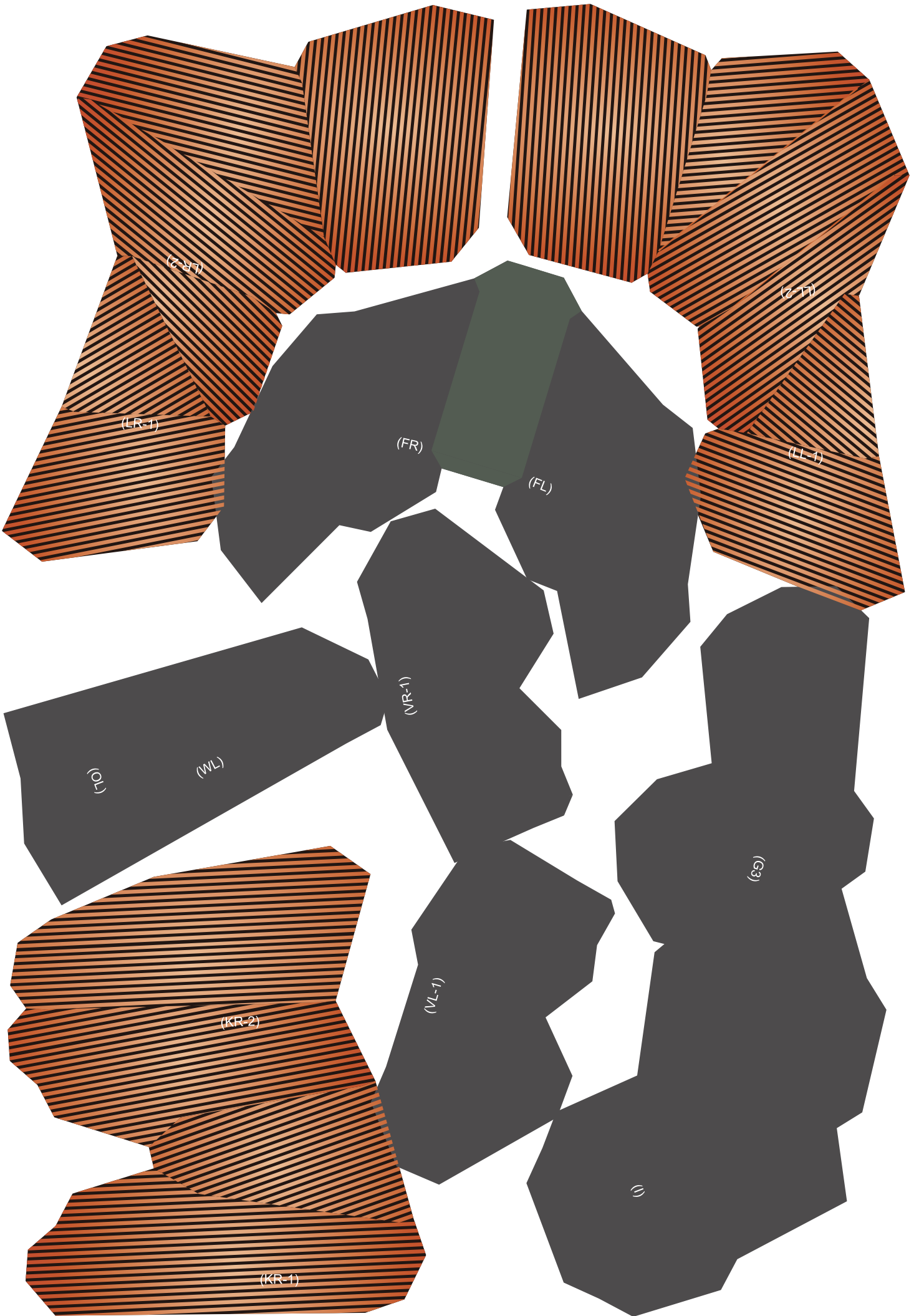

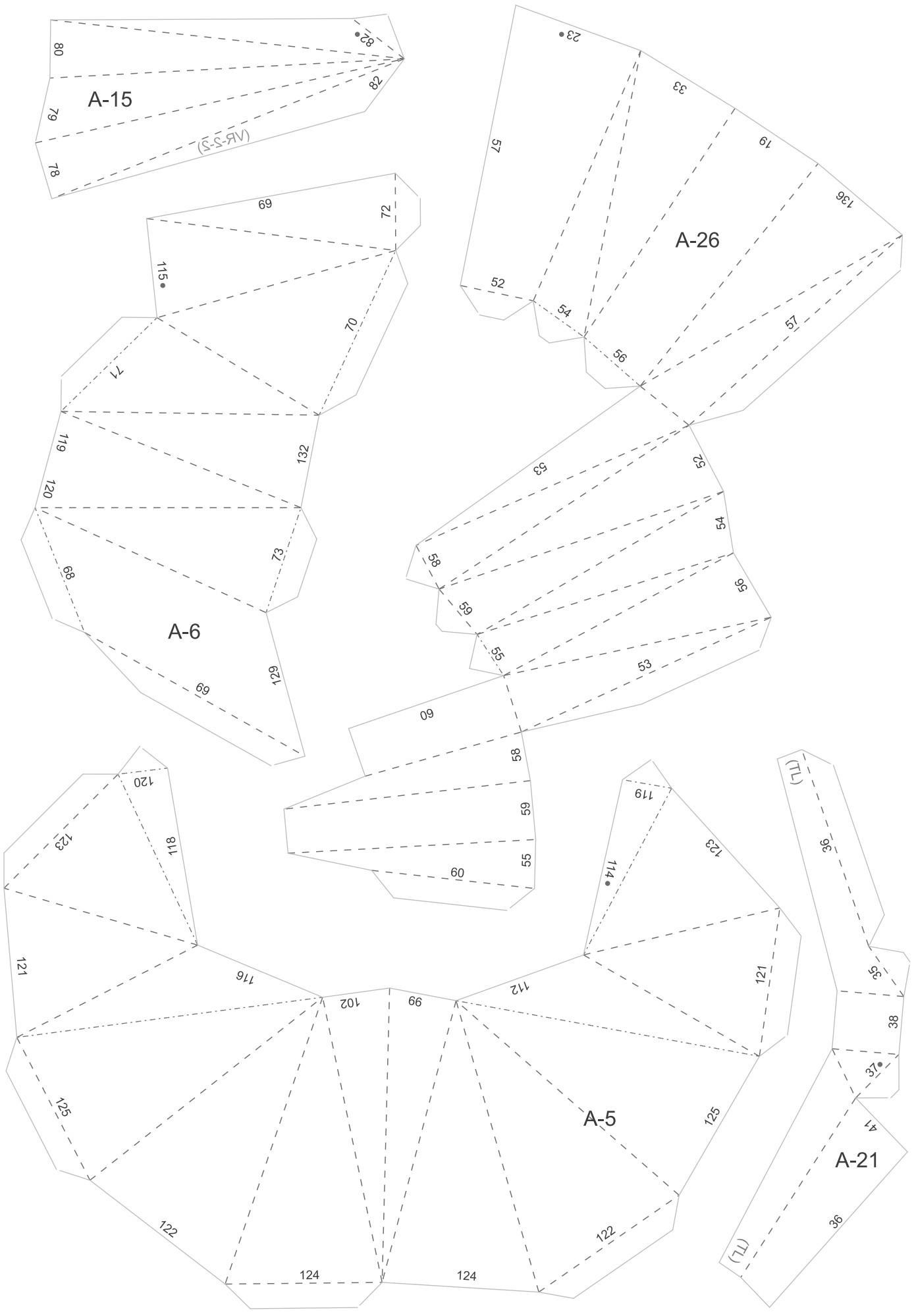

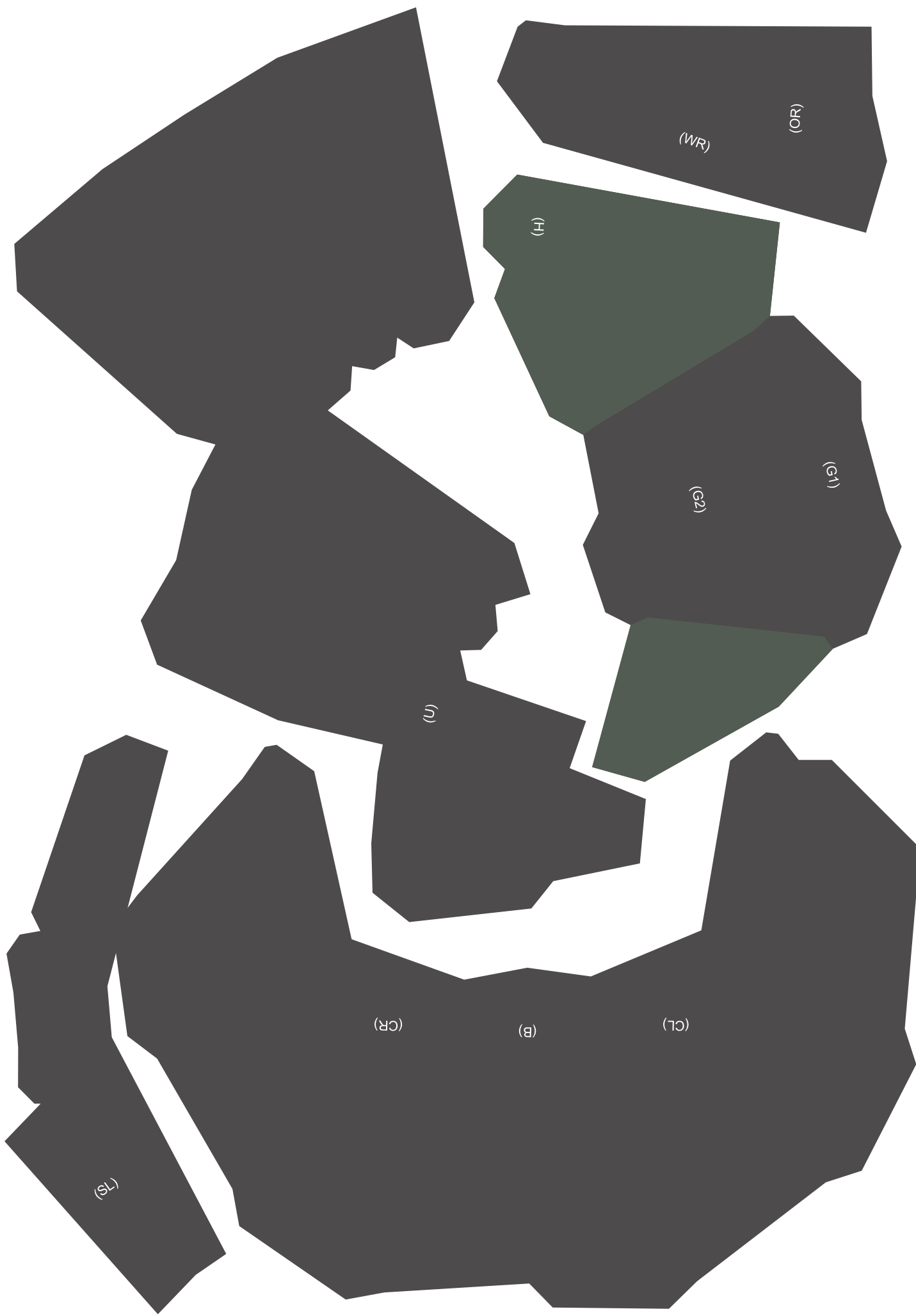

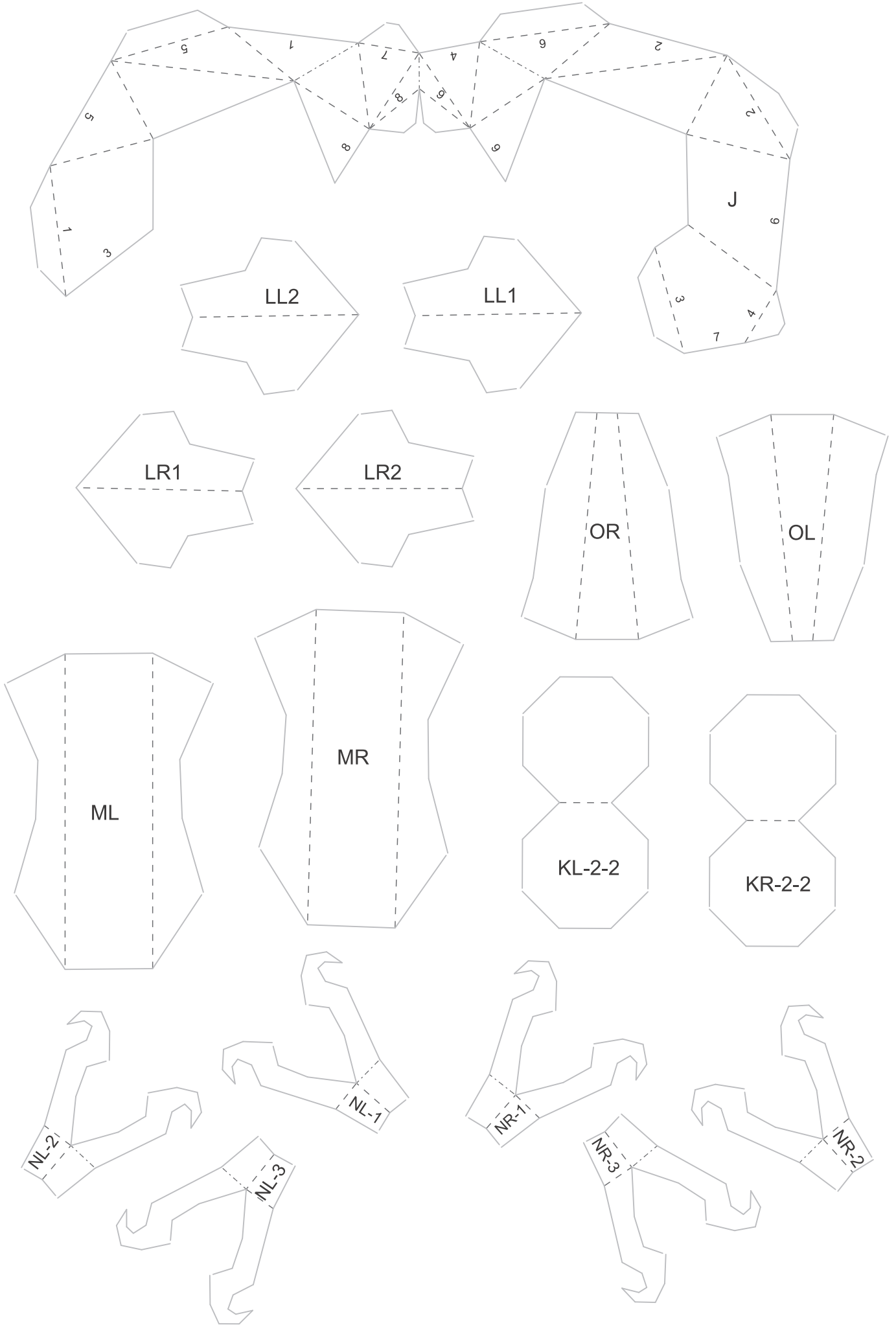

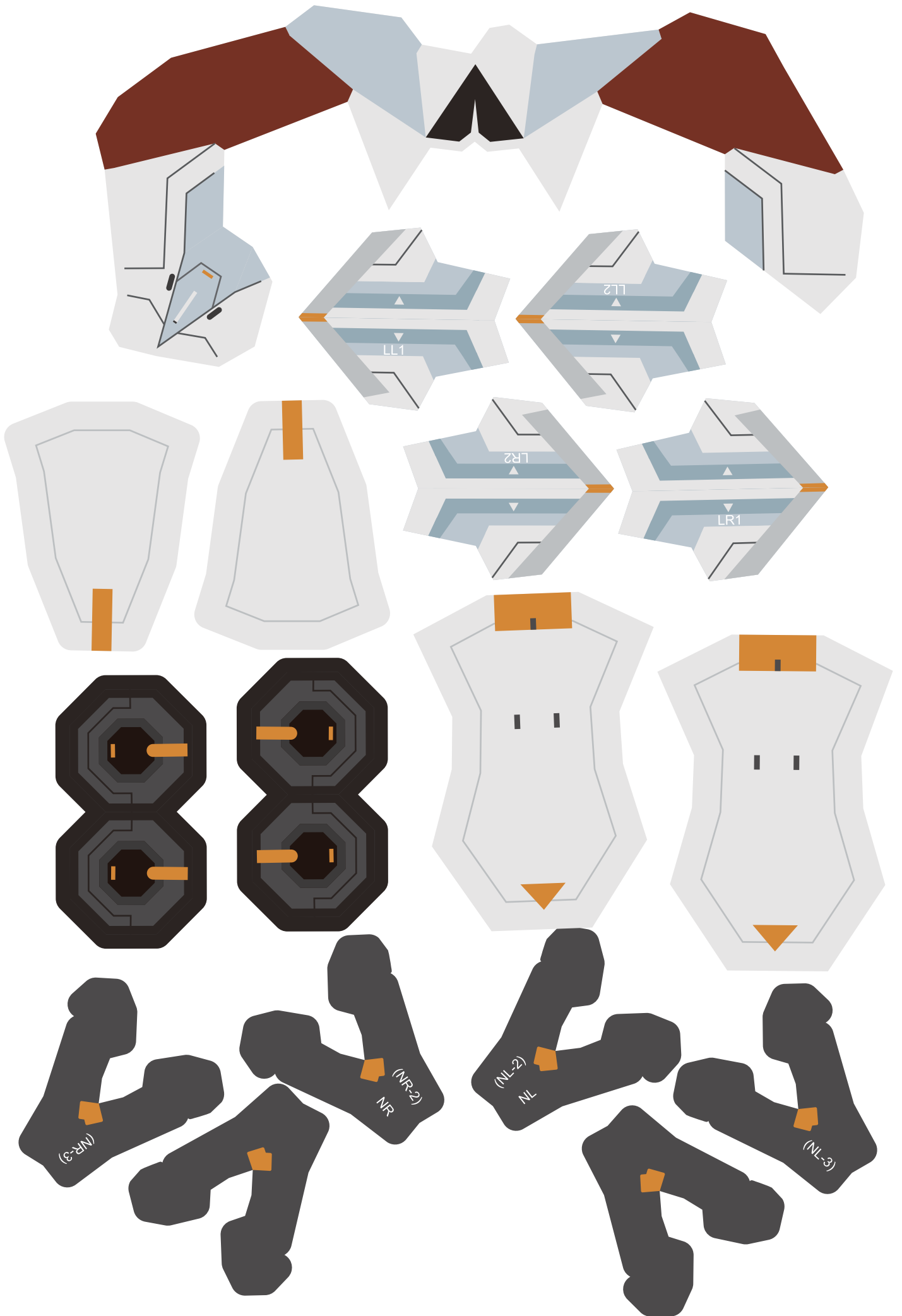



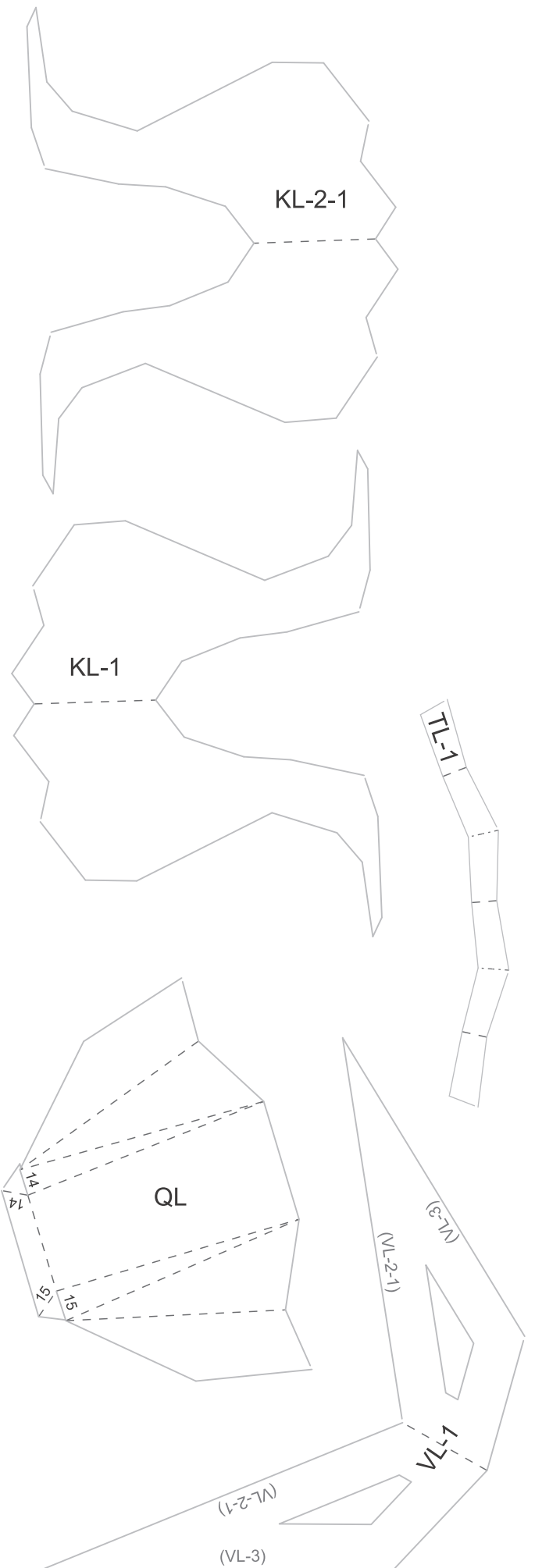
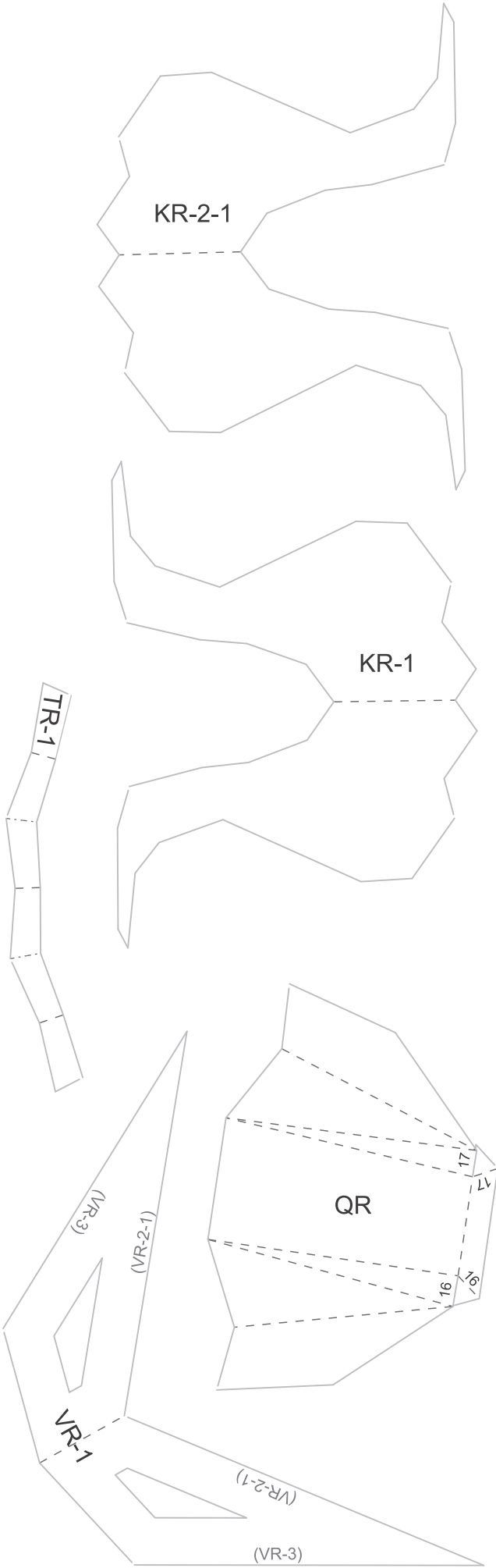



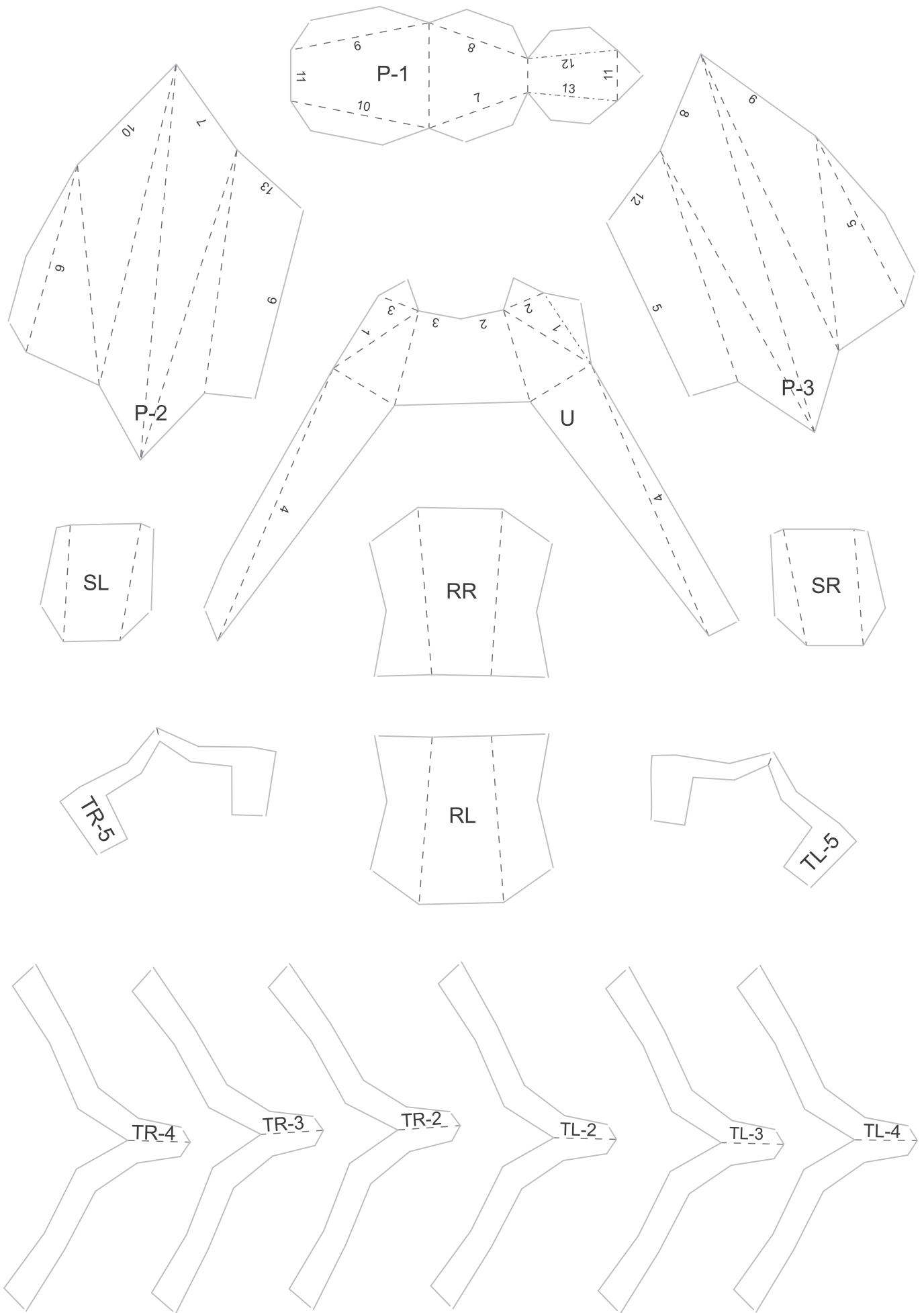



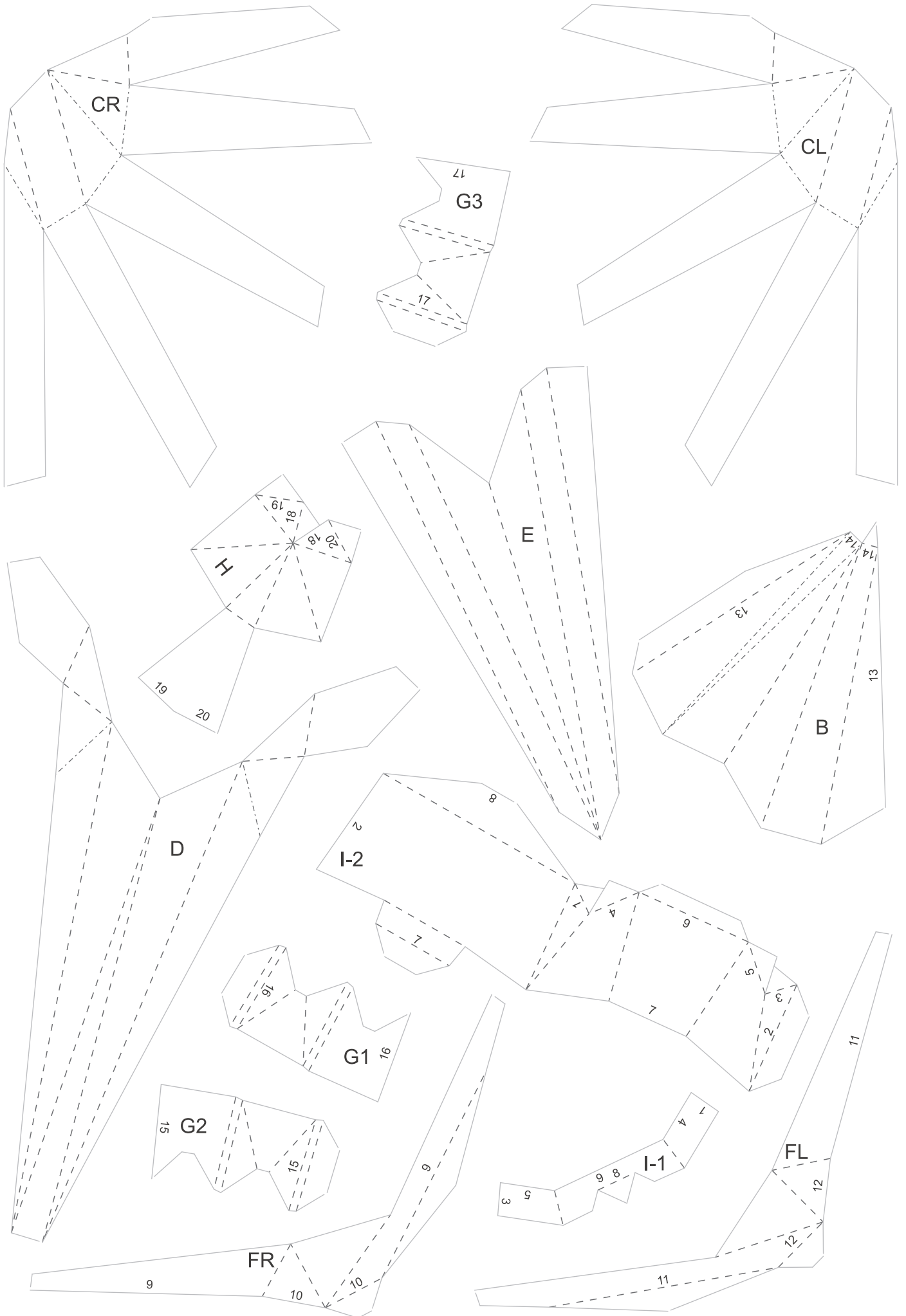



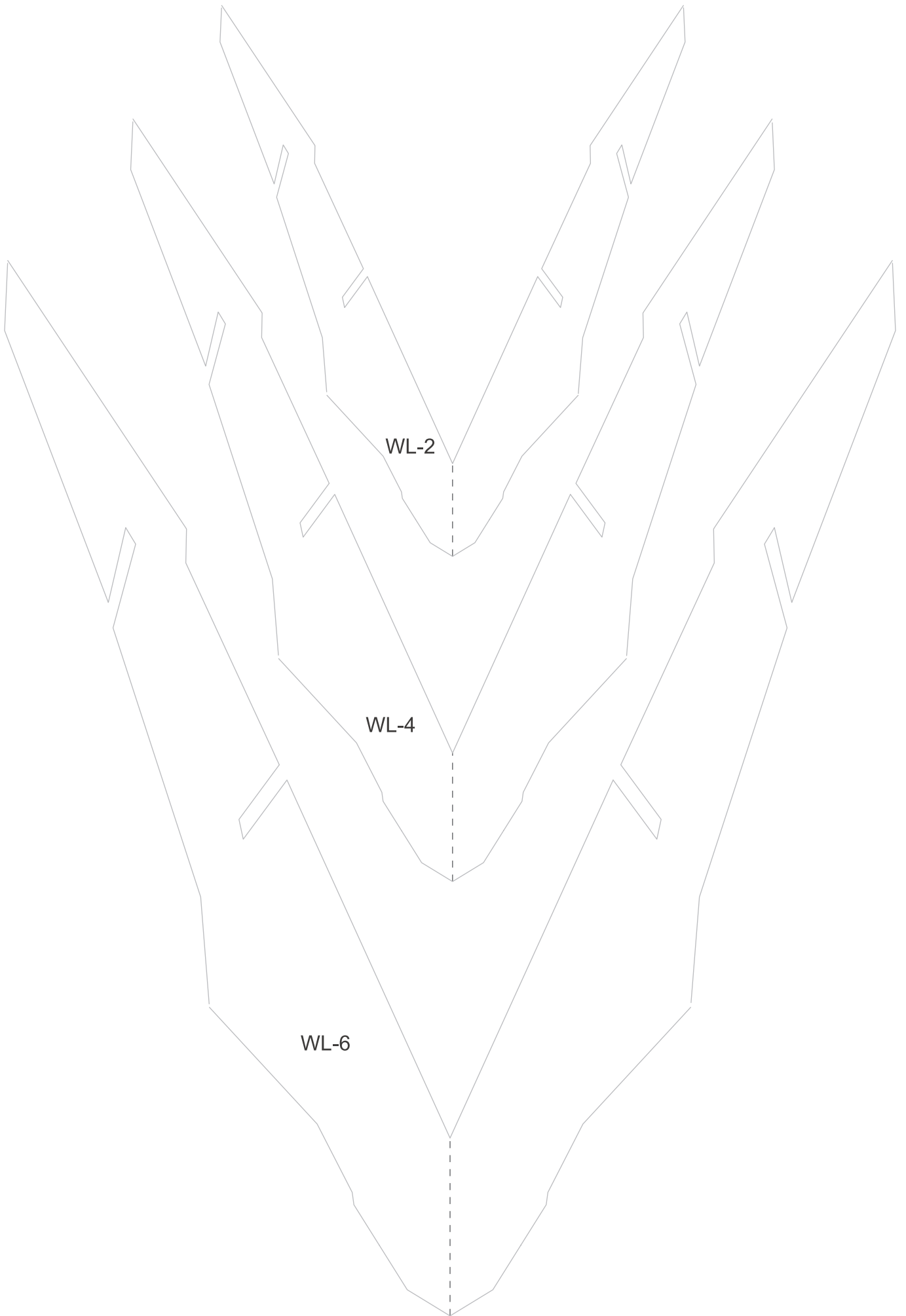

WL-2

WL-4

WL-6

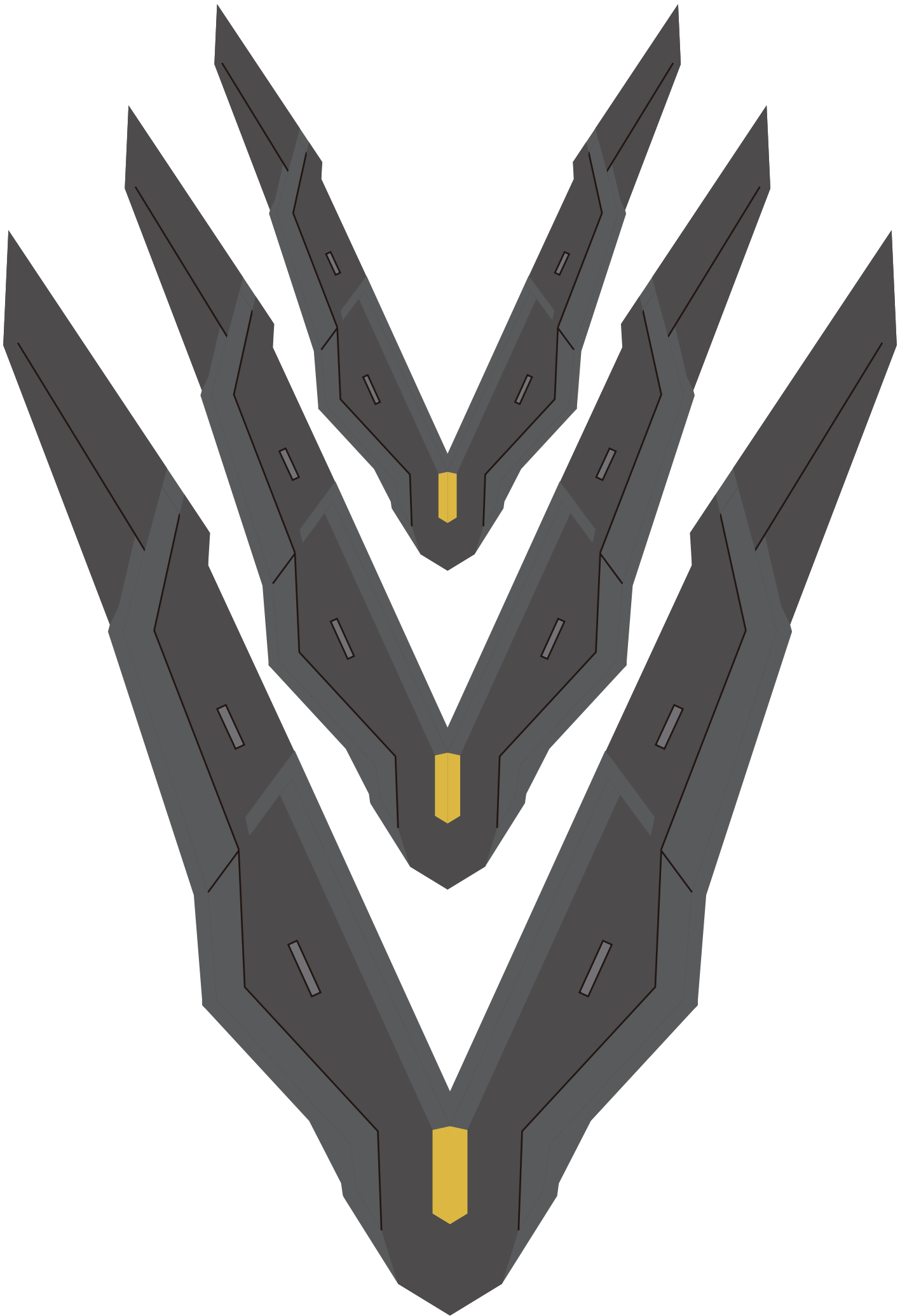



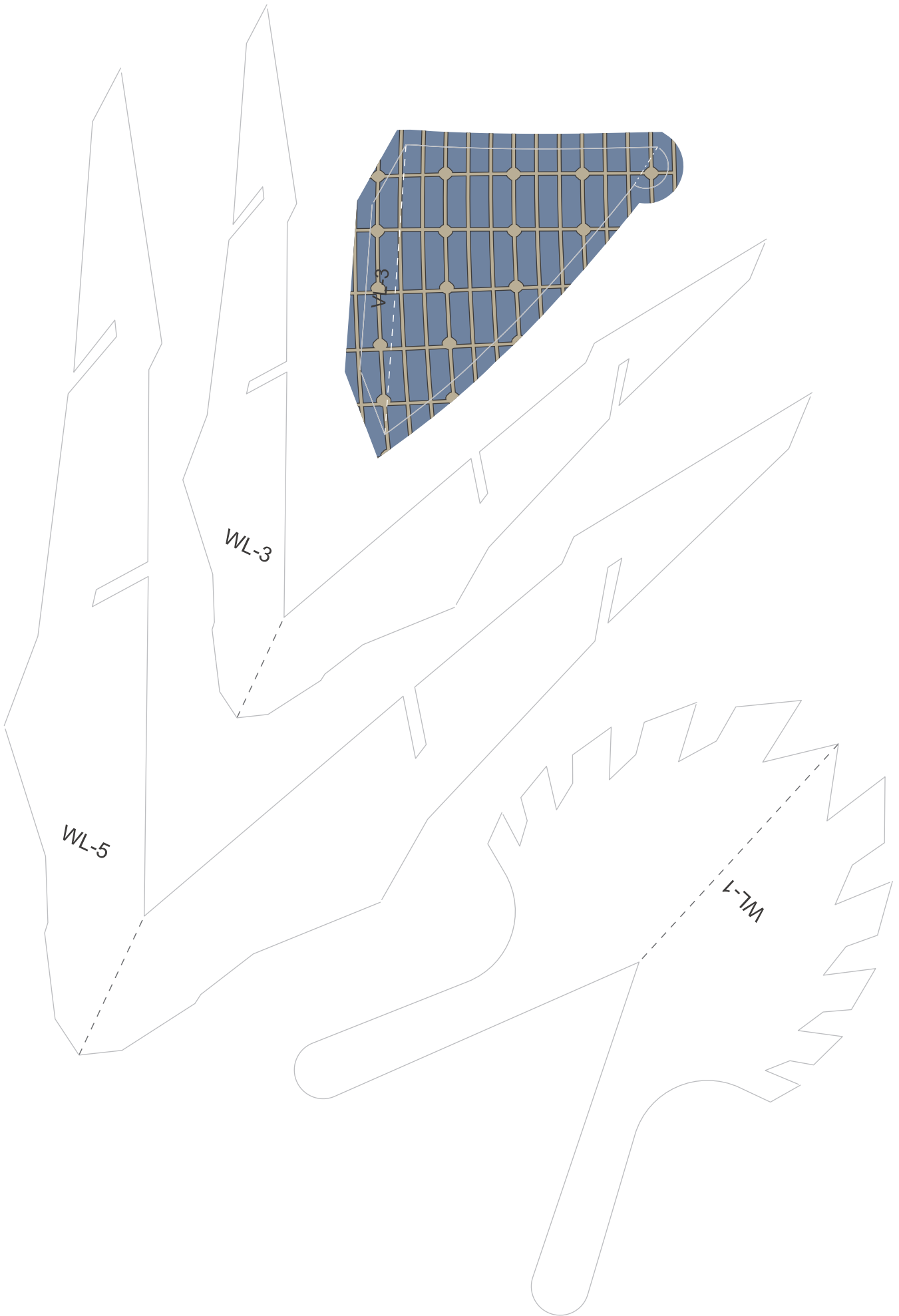

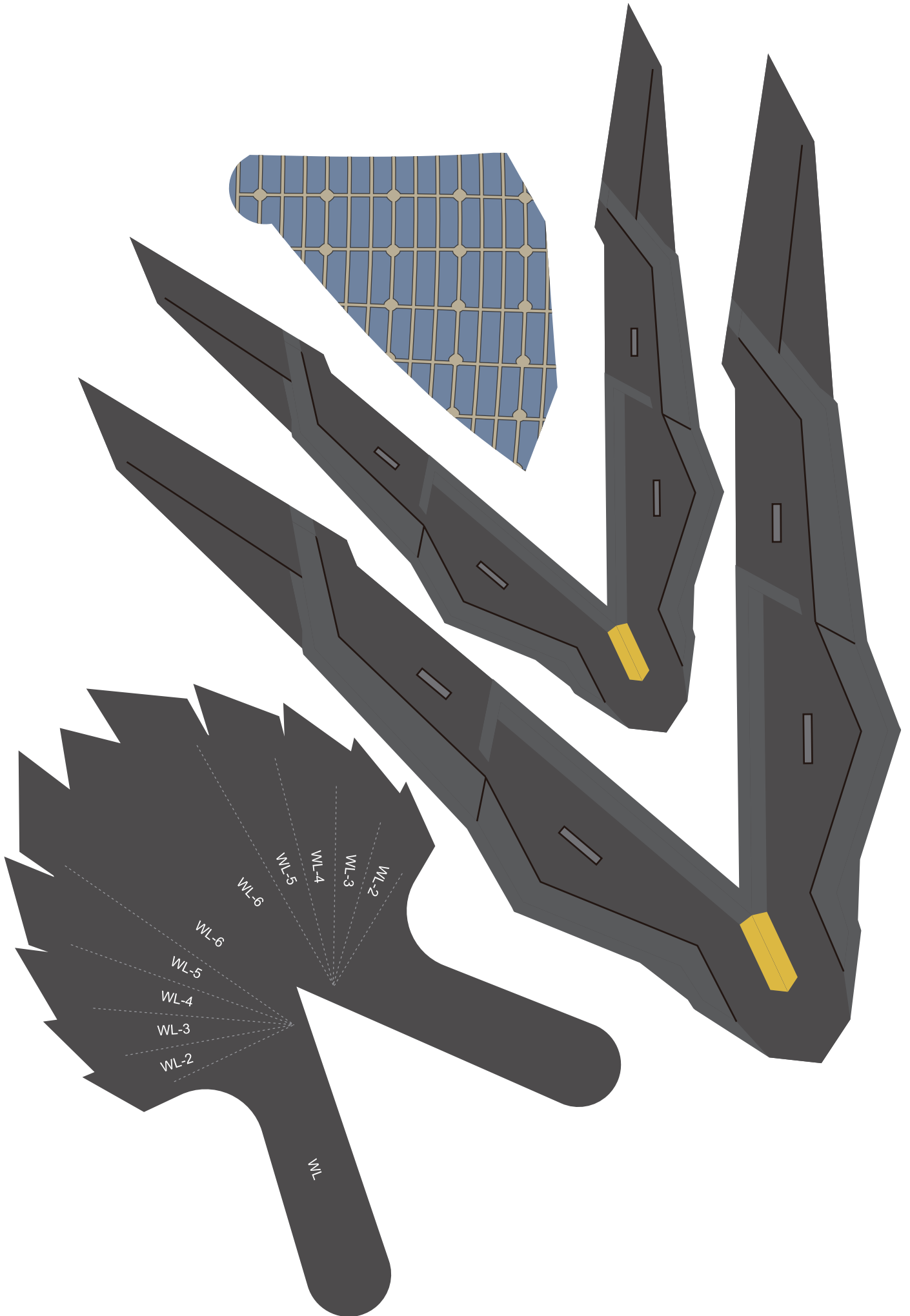

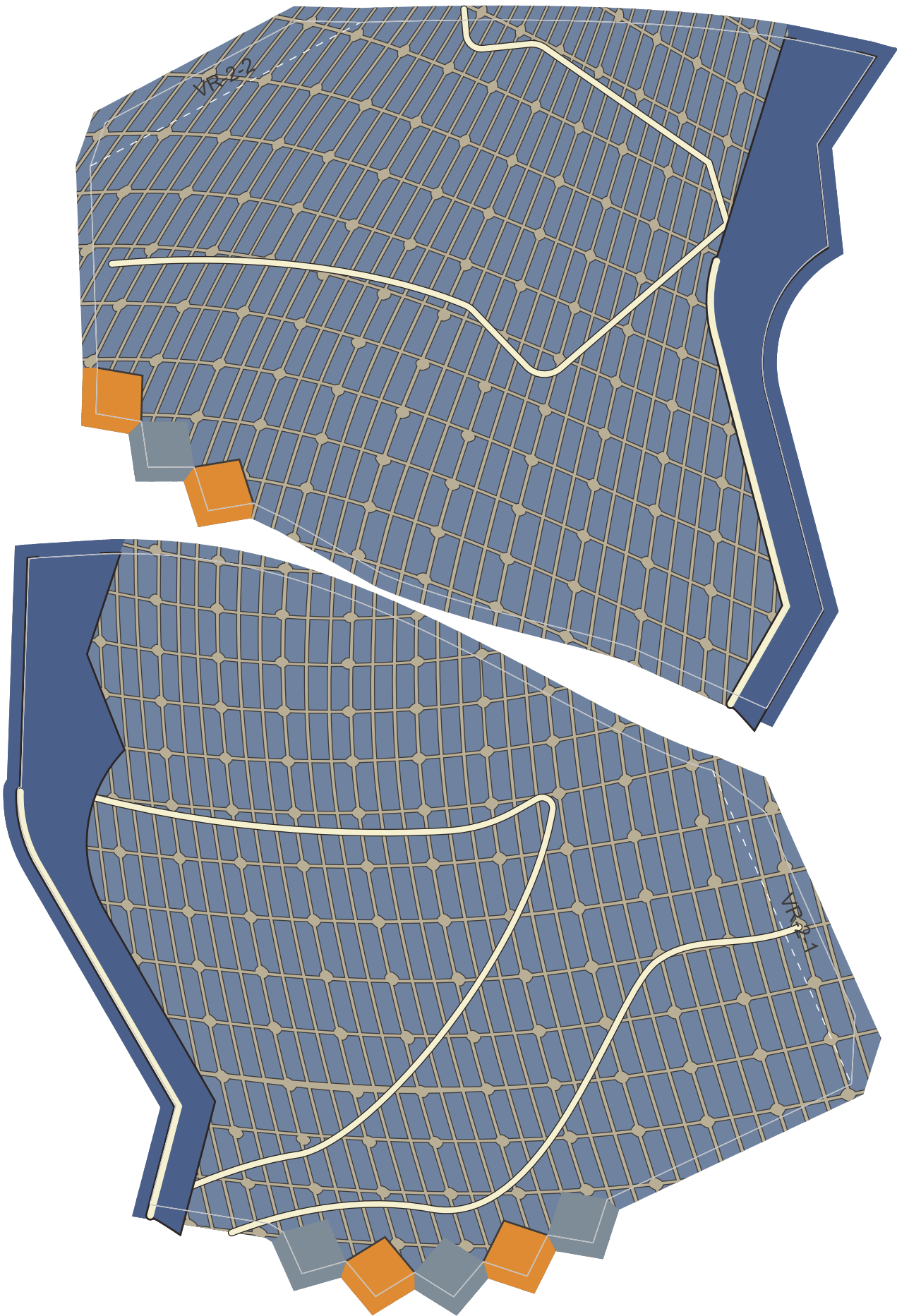

VR 2-2

VR 1-1

