

Figurine din hârtie

SUNWING

Mărime – Adâncime 800 x Lățime 300 x Înălțime 350 mm

Material: 19 de coli de hârtie A4



Produs proiectat de Trunk Cultural & Creative Co., LTD.

©2022 Sony Interactive Entertainment Europe. Dezvoltat de Guerrilla.

Horizon Forbidden West este o marcă comercială a Sony Interactive Entertainment LLC.

Se recomandă hârtie de imprimantă

Produsul finit oficial se imprimă pe hârtie de aproximativ 235 g/m².

Imprimă pe hârtie A4 de cel puțin 160 g/m² – 180 g/m².

Alege imprimarea color pe ambele fețe, cu răsturnare pe muchia lungă.

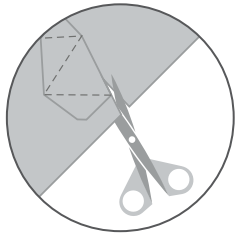

1. Decupează formele urmând liniile continue.

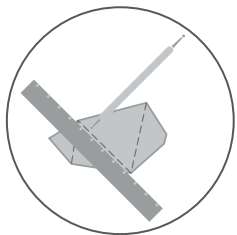

2. Folosește un creion de cutat (sau partea boantă a cutterului) ca să marchezi hârtia de-a lungul liniilor punctate.

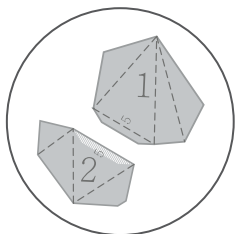

3. Lipește sau introdu piesele în ordinea numerelor (numere mari), apoi potrivește numerele mici și dă cu adeziv pe aripioare (nu e important să respecti ordinea numerelor)

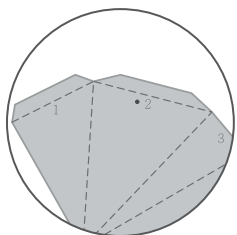

4. Începe să dai cu adeziv pornind de la aripioarele marcate cu „.” ca să-ți fie mai ușor să parcurgi pașii următori

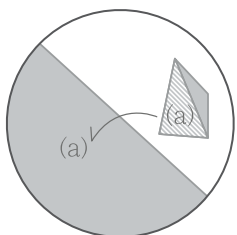

5. După ce assemblezi piesele suplimentare, potrivește numerlele de pe piese cu aceleași numere de pe corpul principal, apoi lipește-le pe zona dată cu adeziv sau introdu-le în locul potrivit.

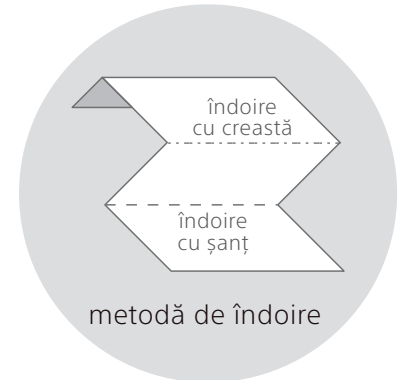

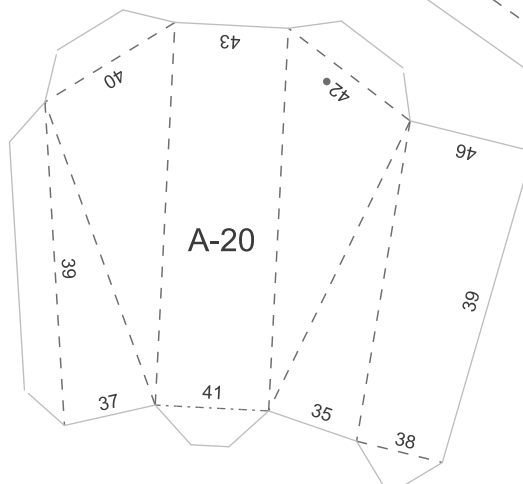
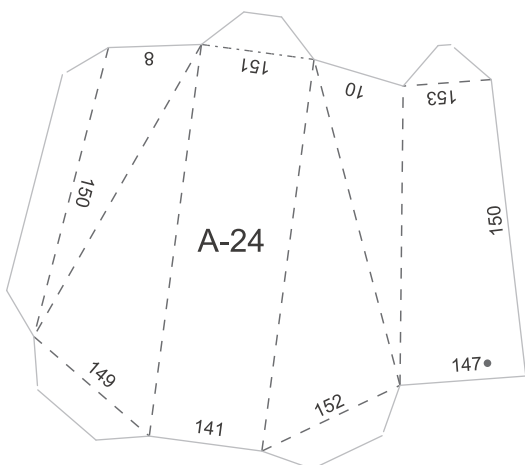
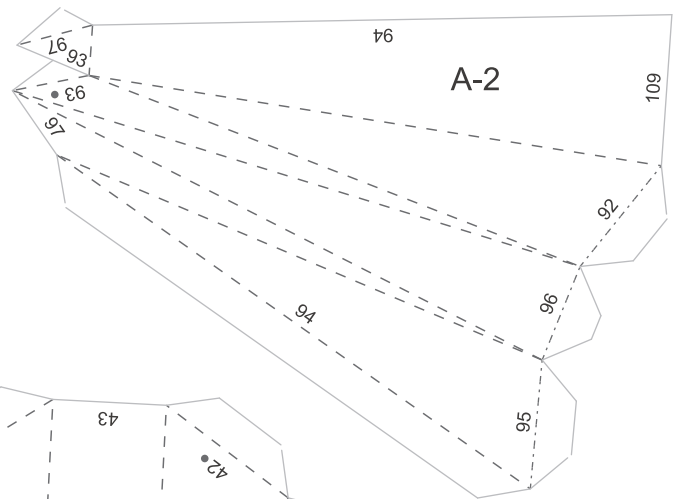
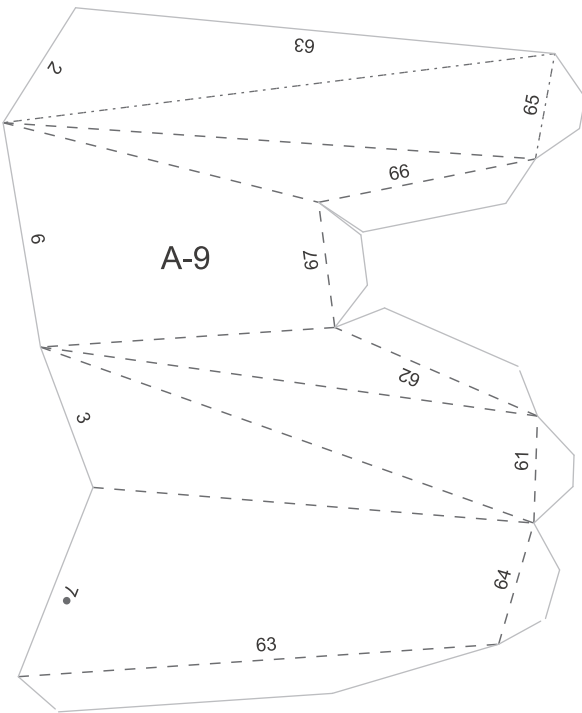
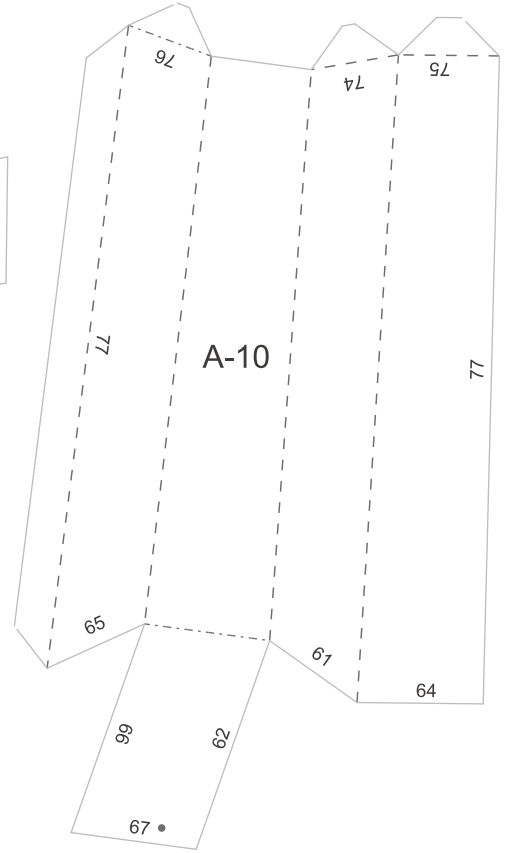
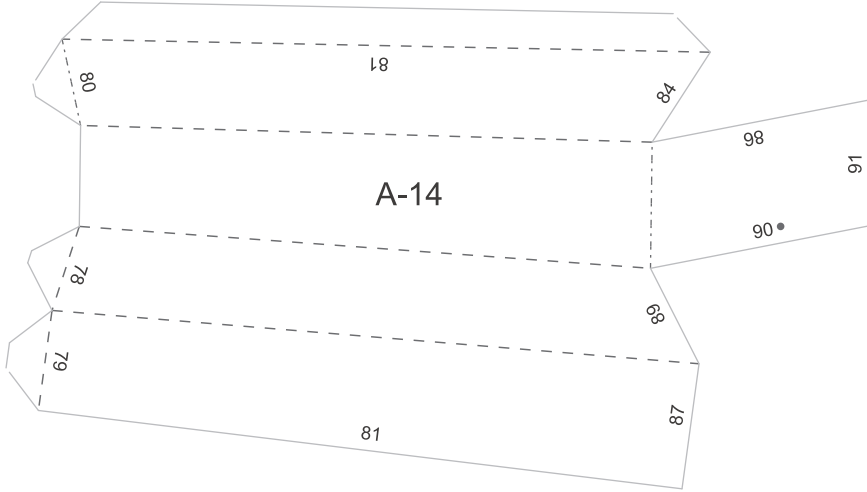
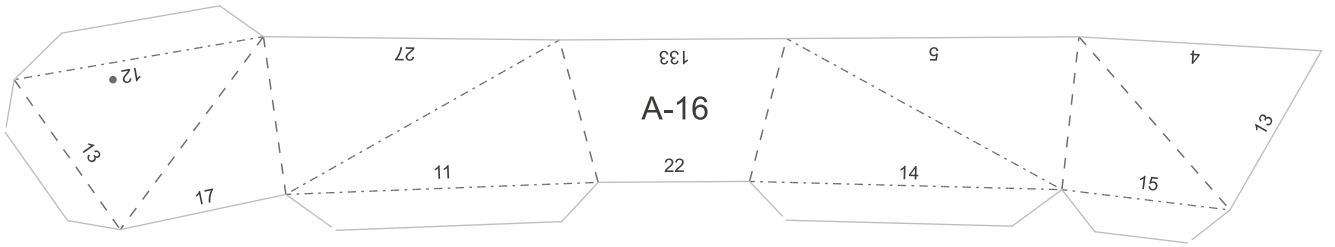

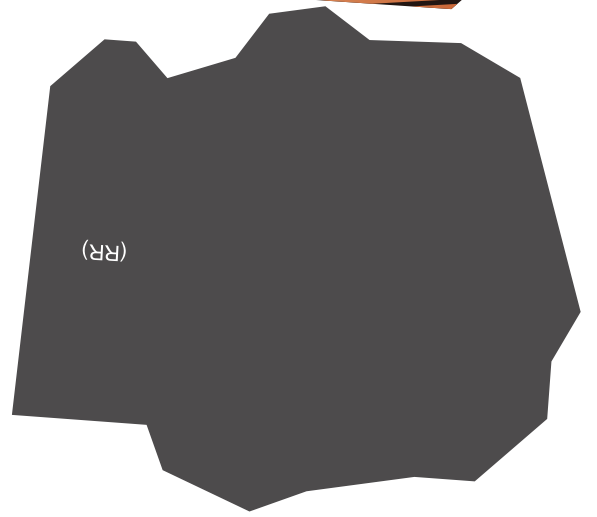
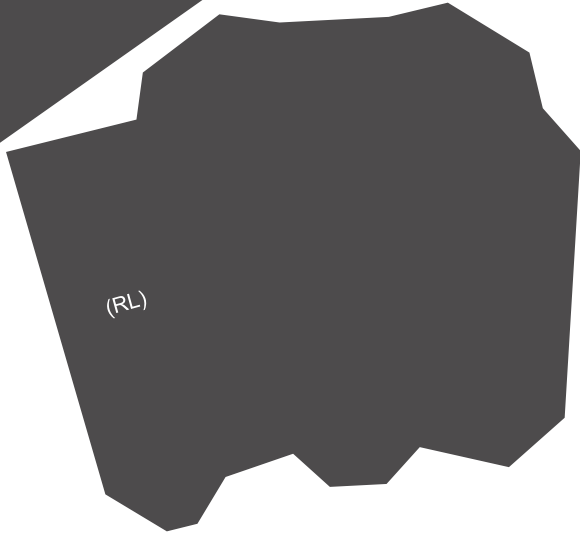
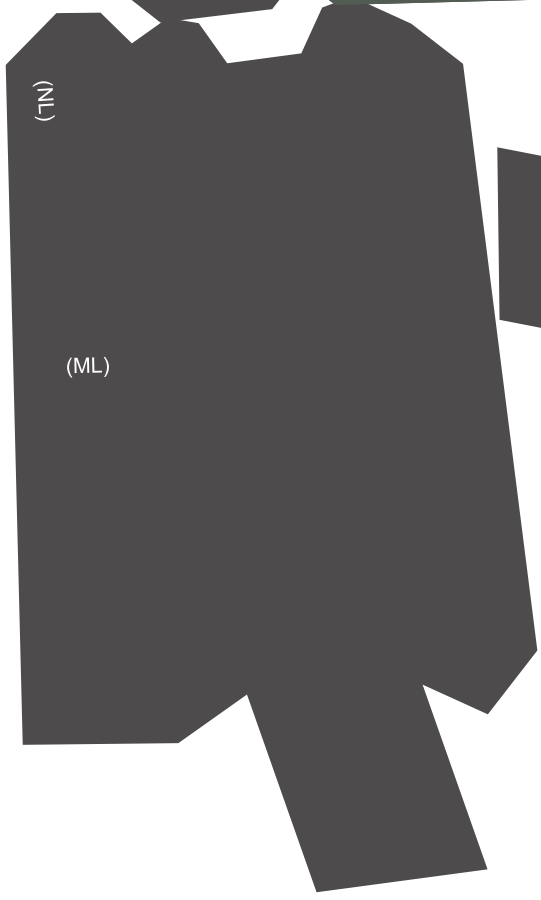
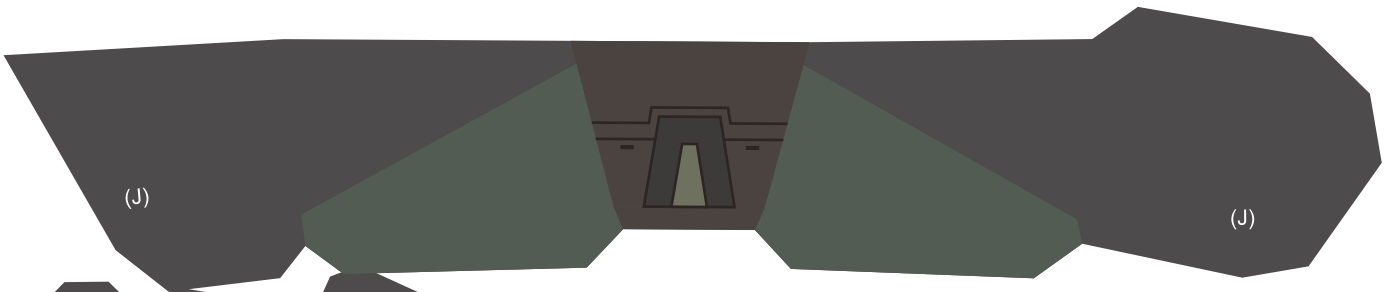

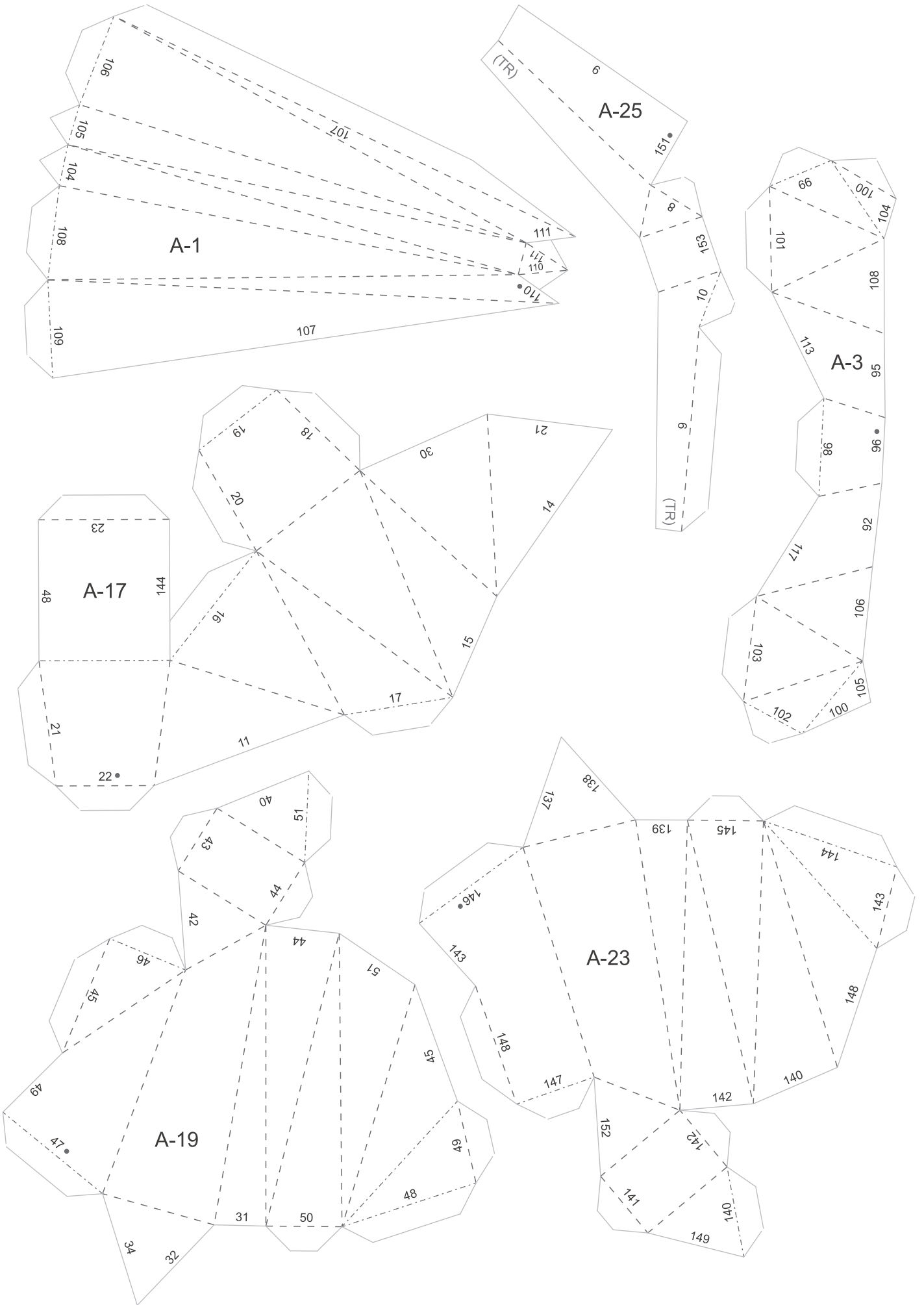

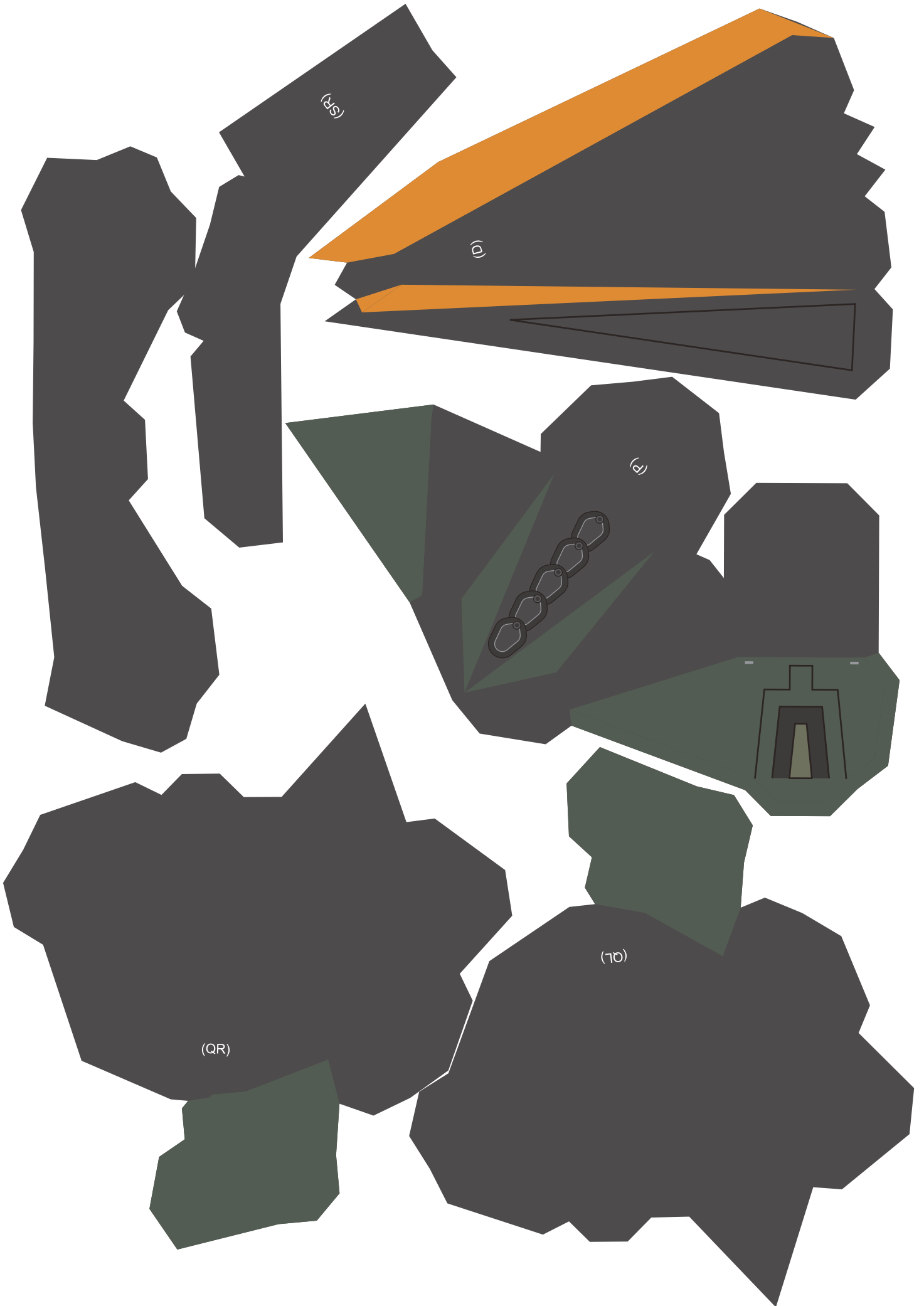

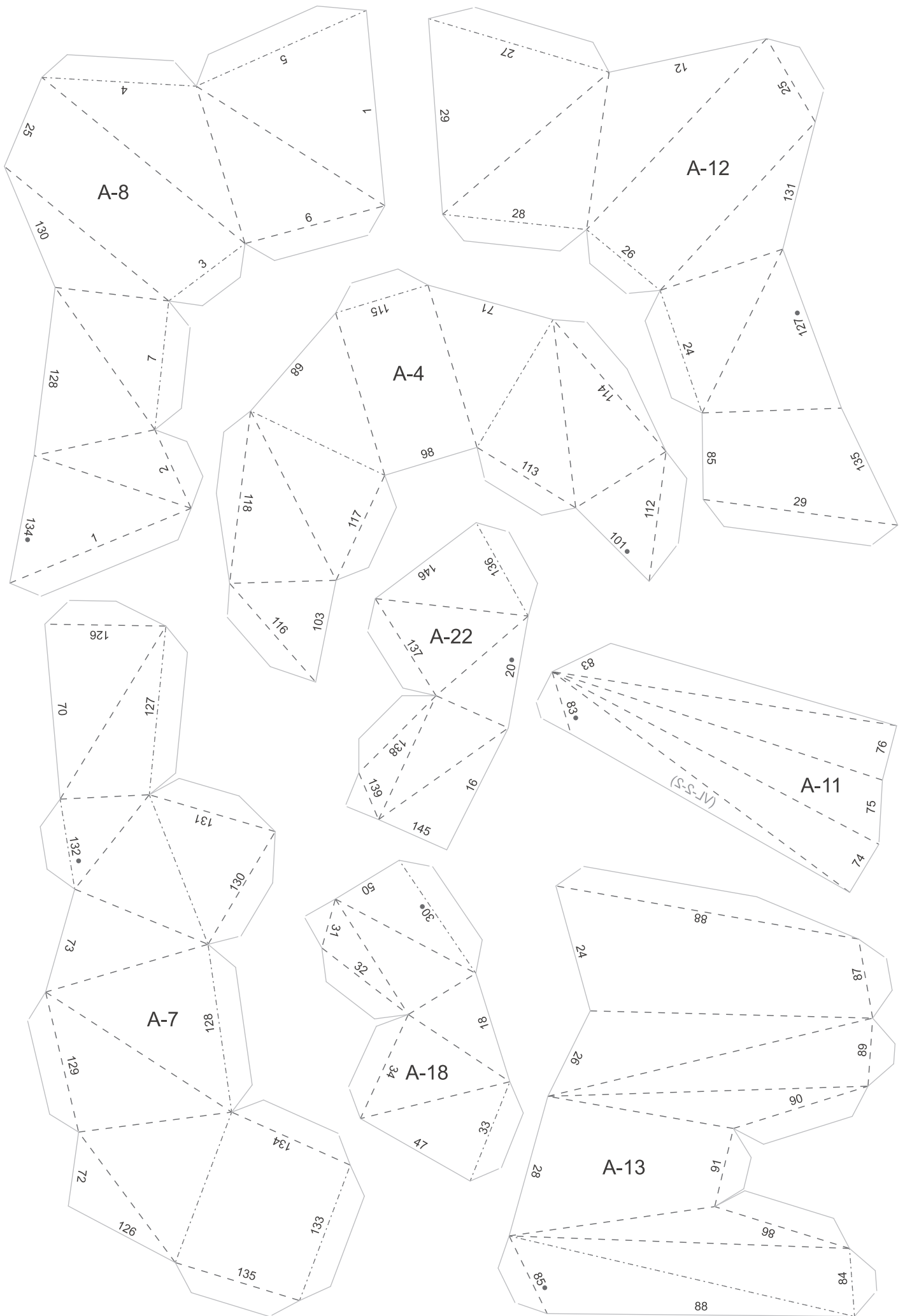

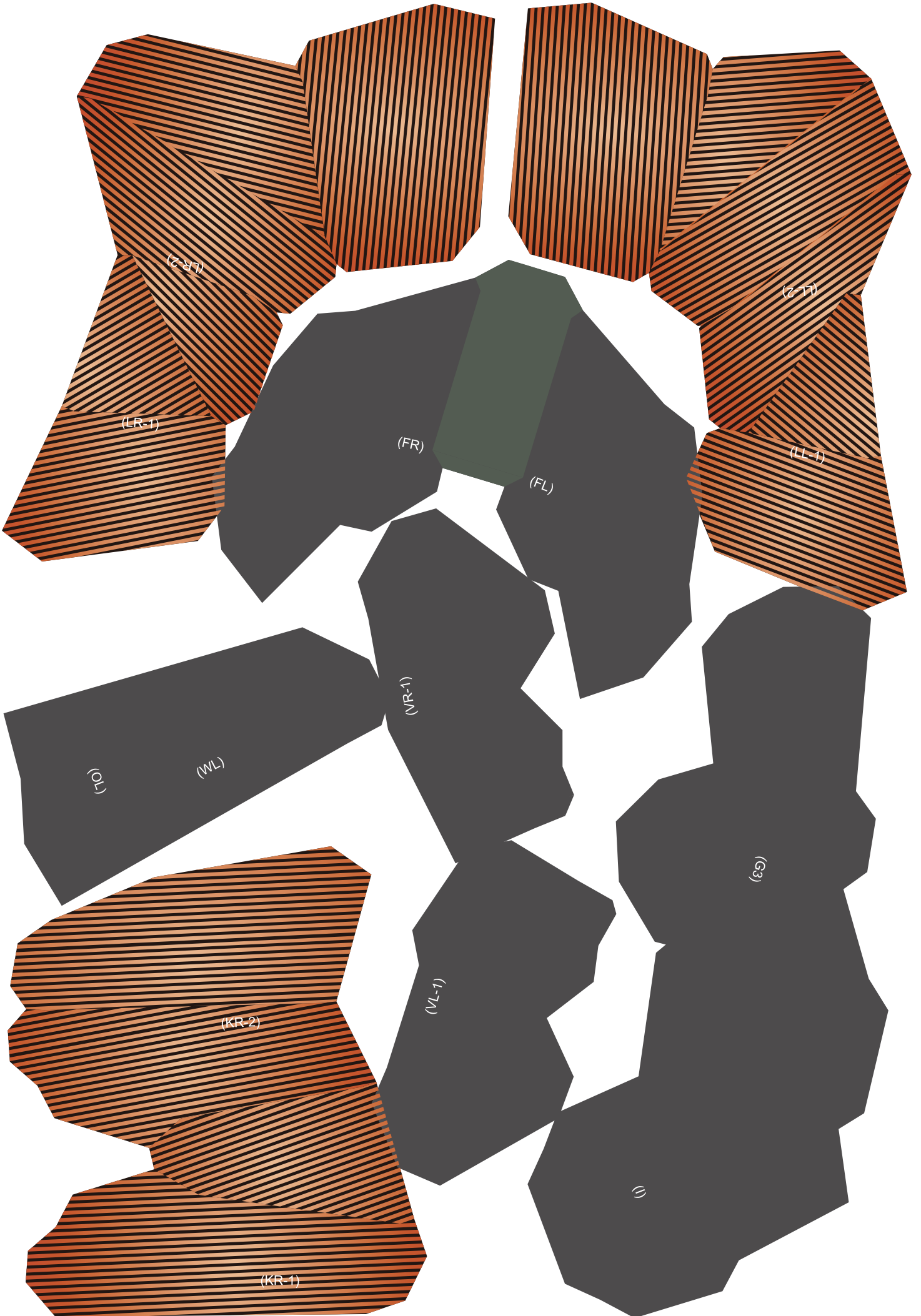

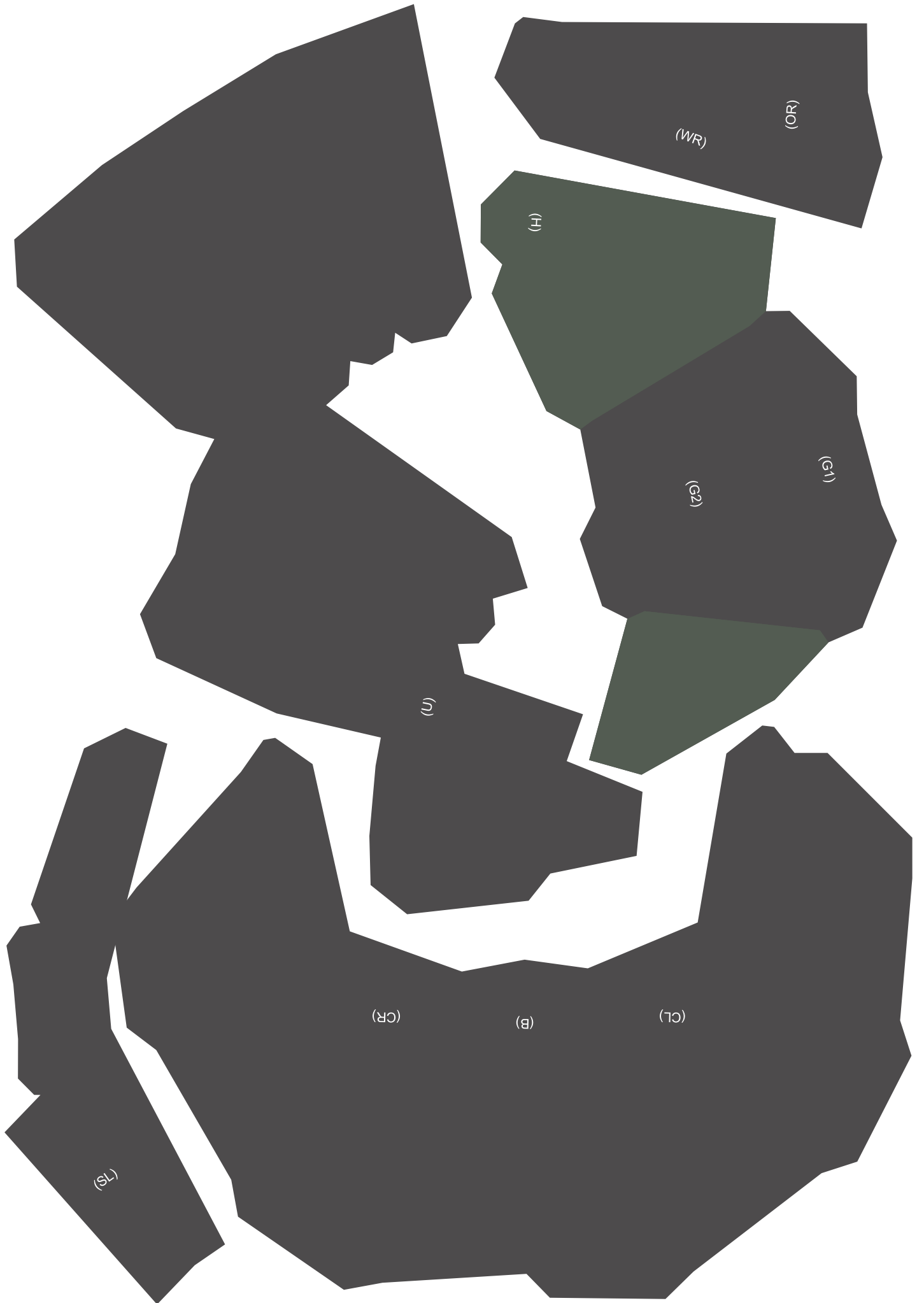

(WR)

(OR)

(H)

(G2)

(G1)

(S)

(CR)

(B)

(CL)

(TS)

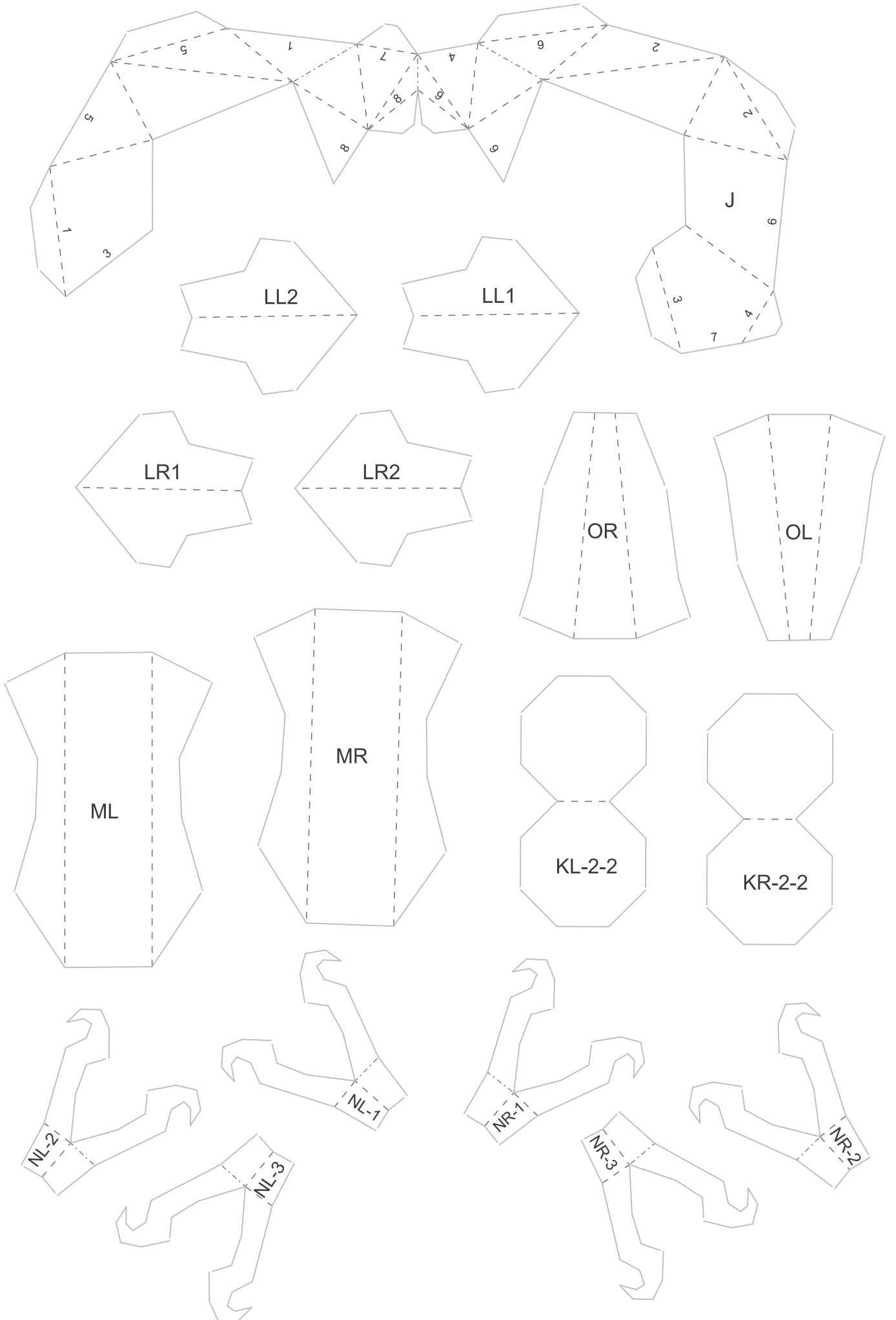

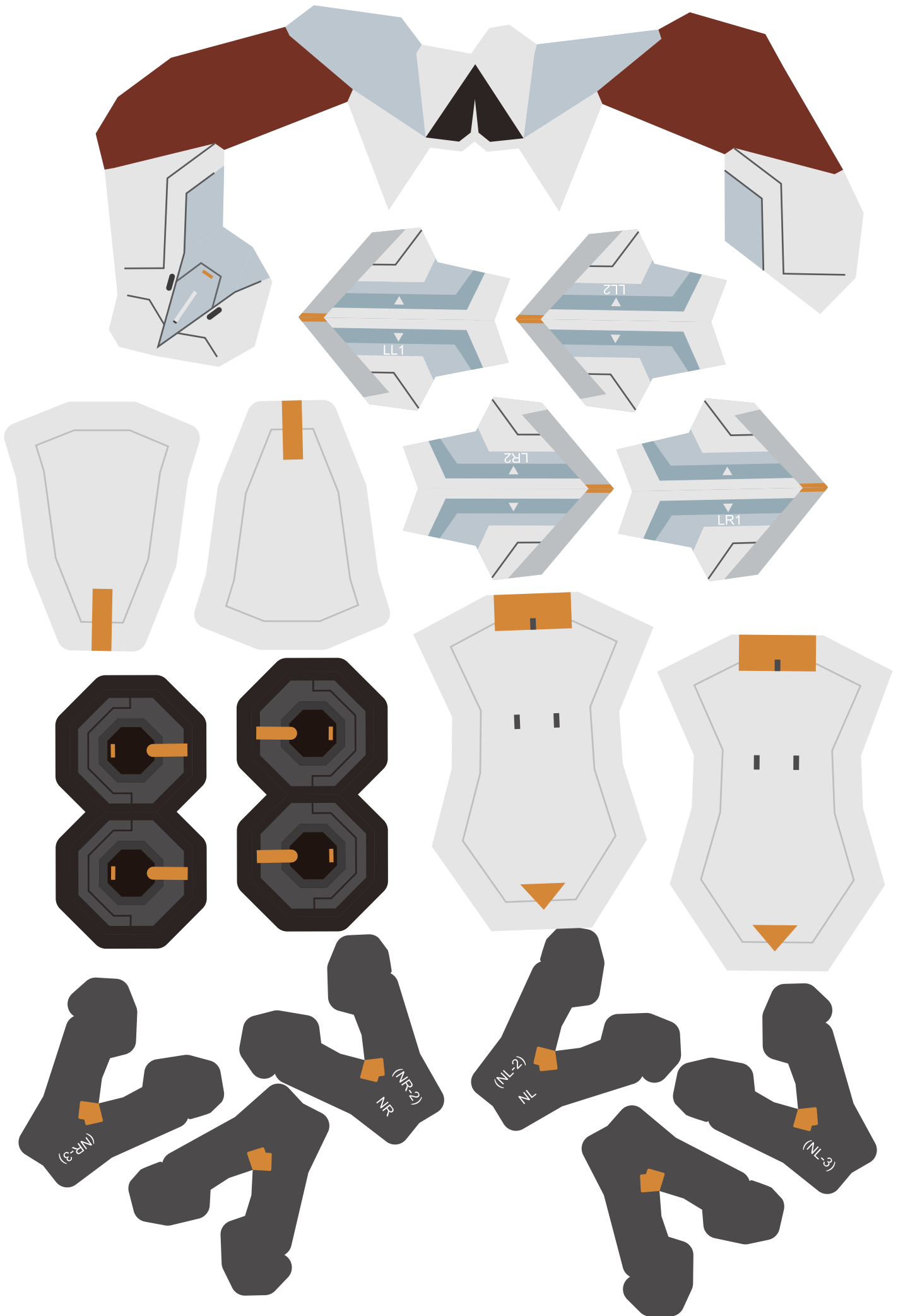

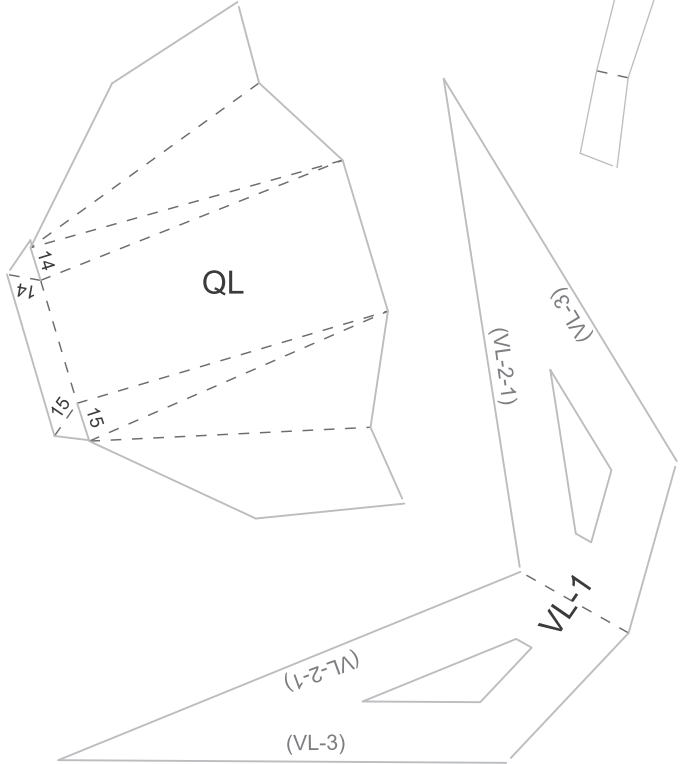
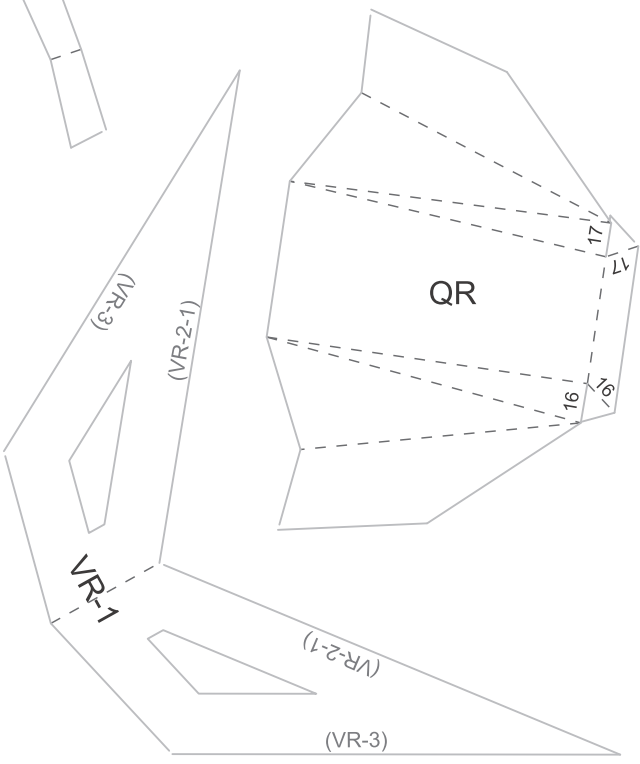
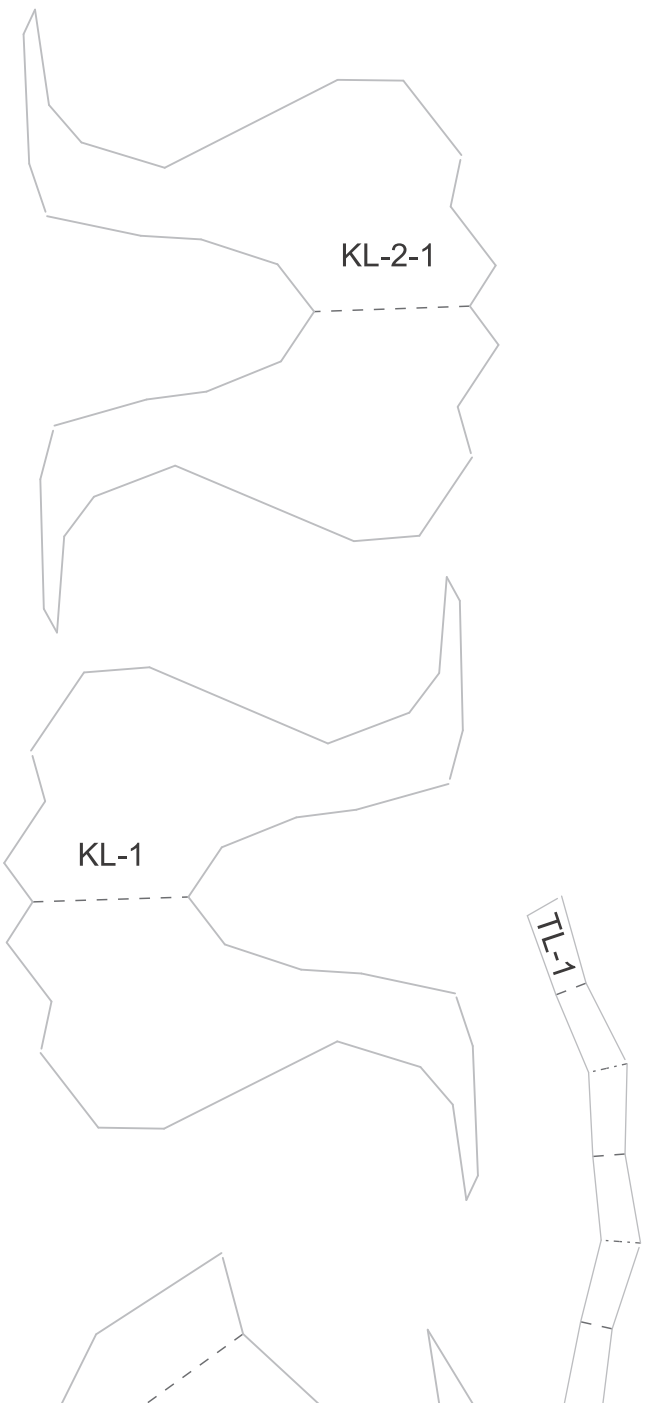
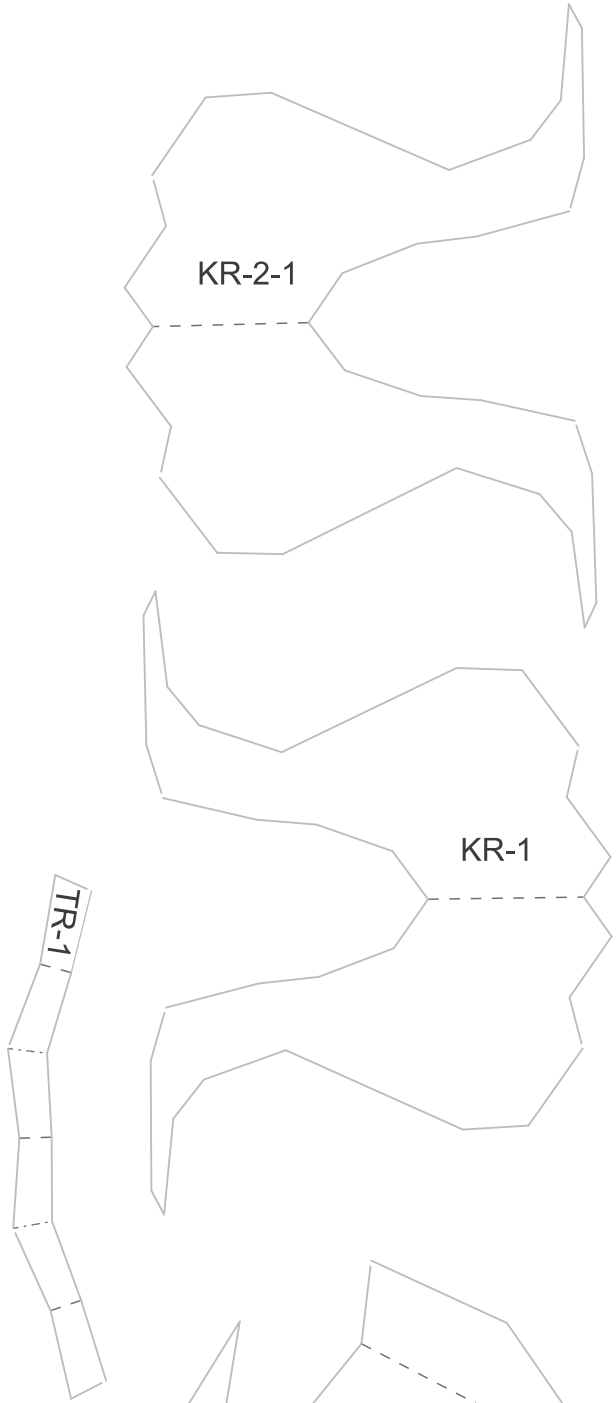



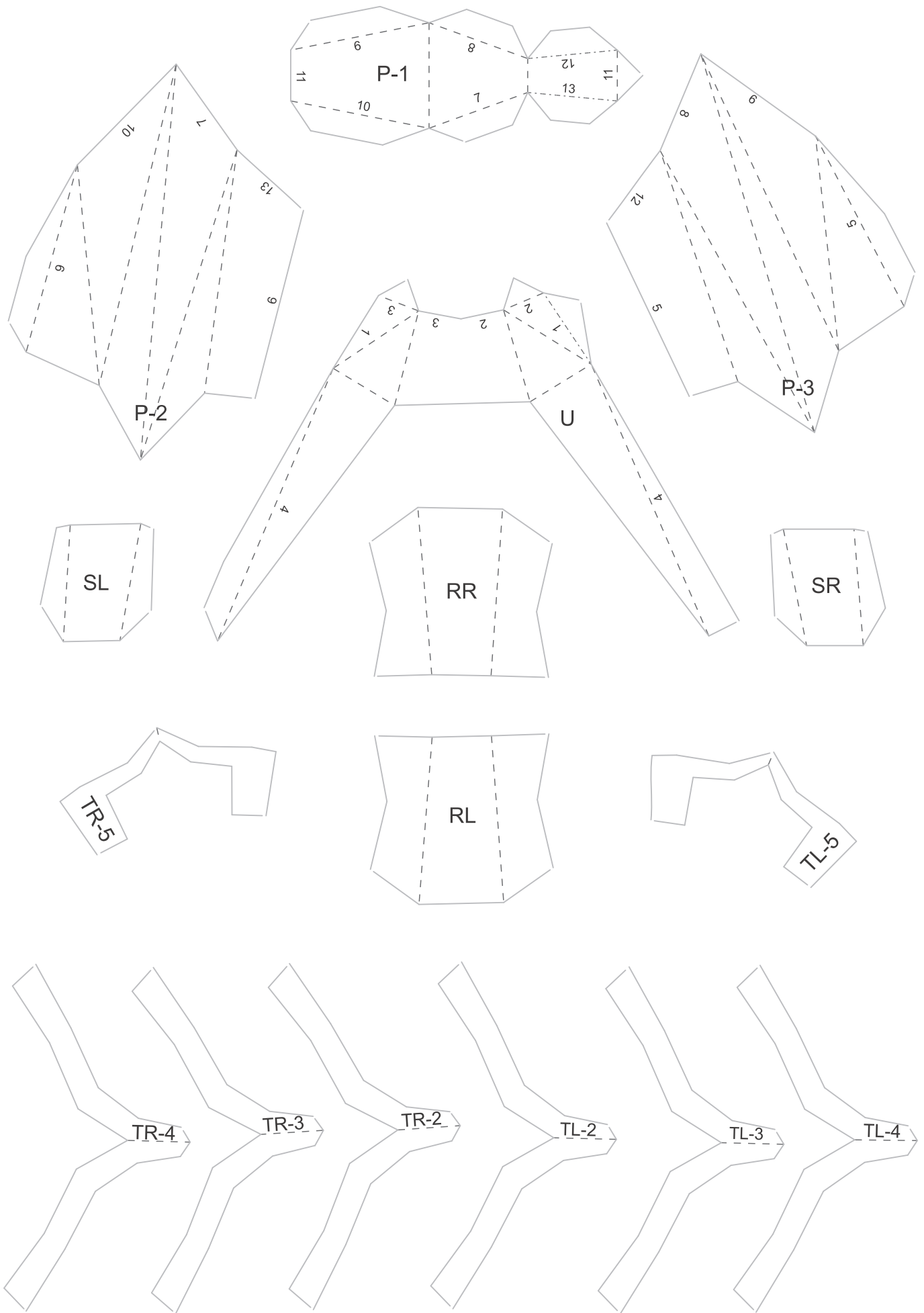



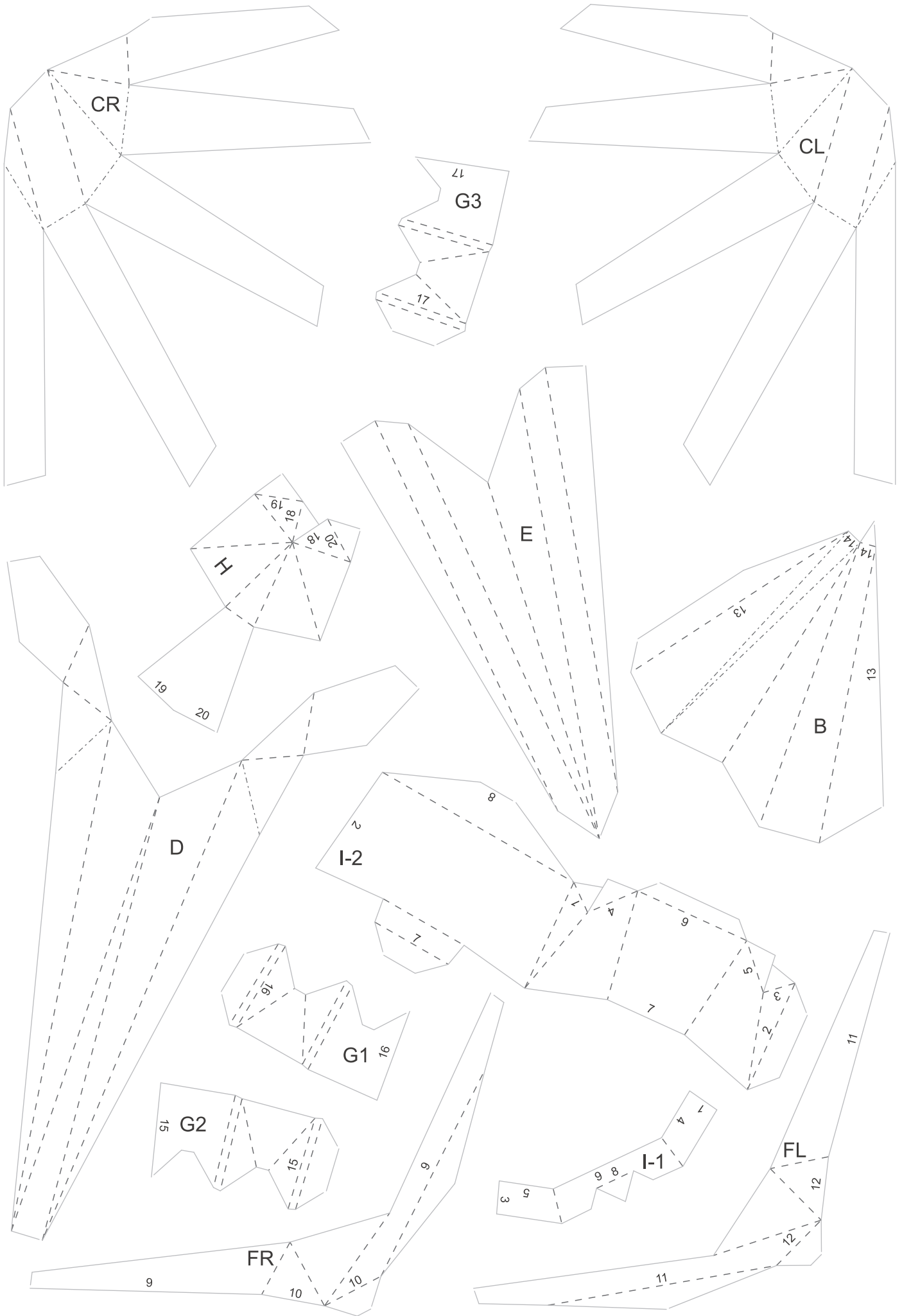



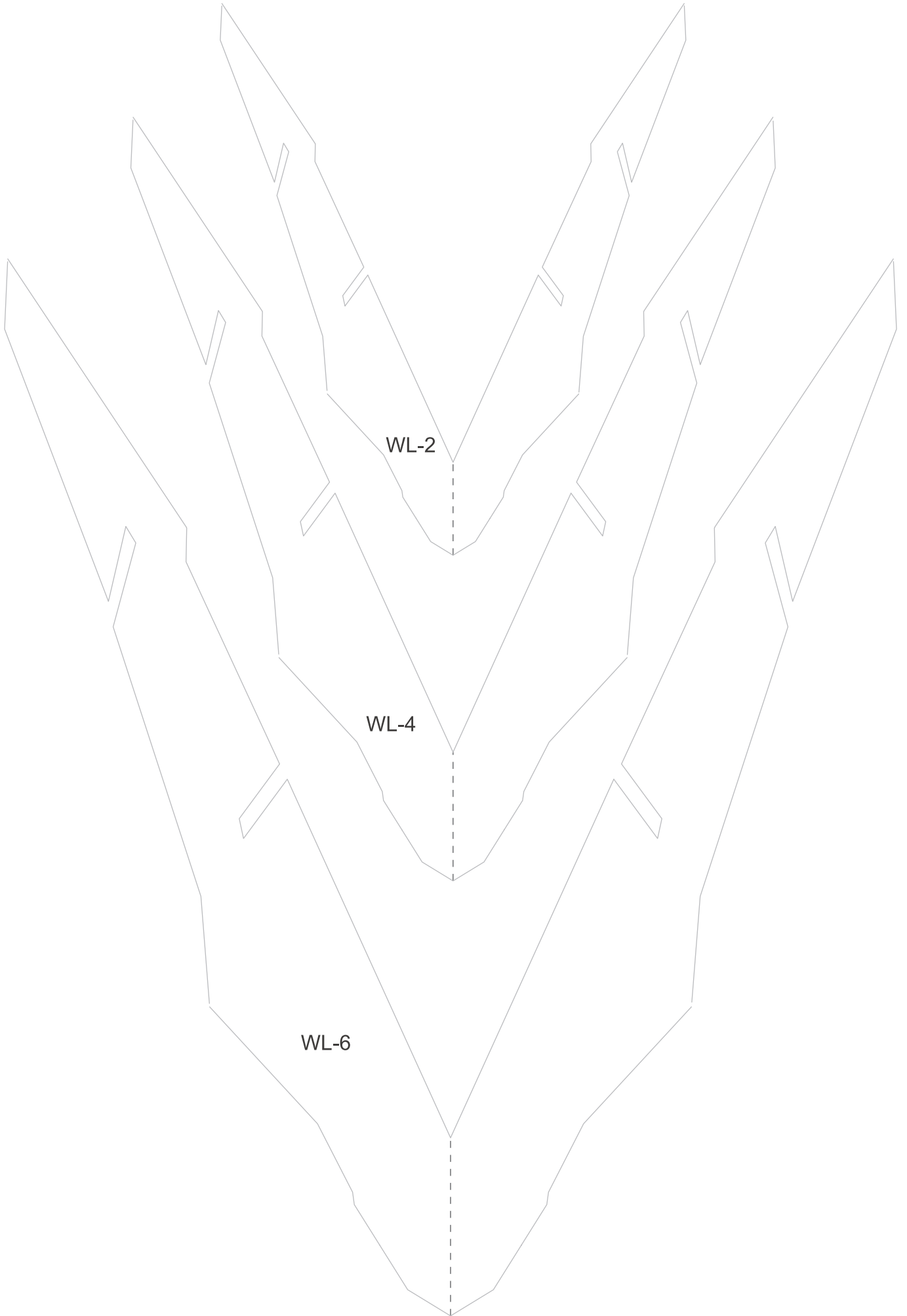

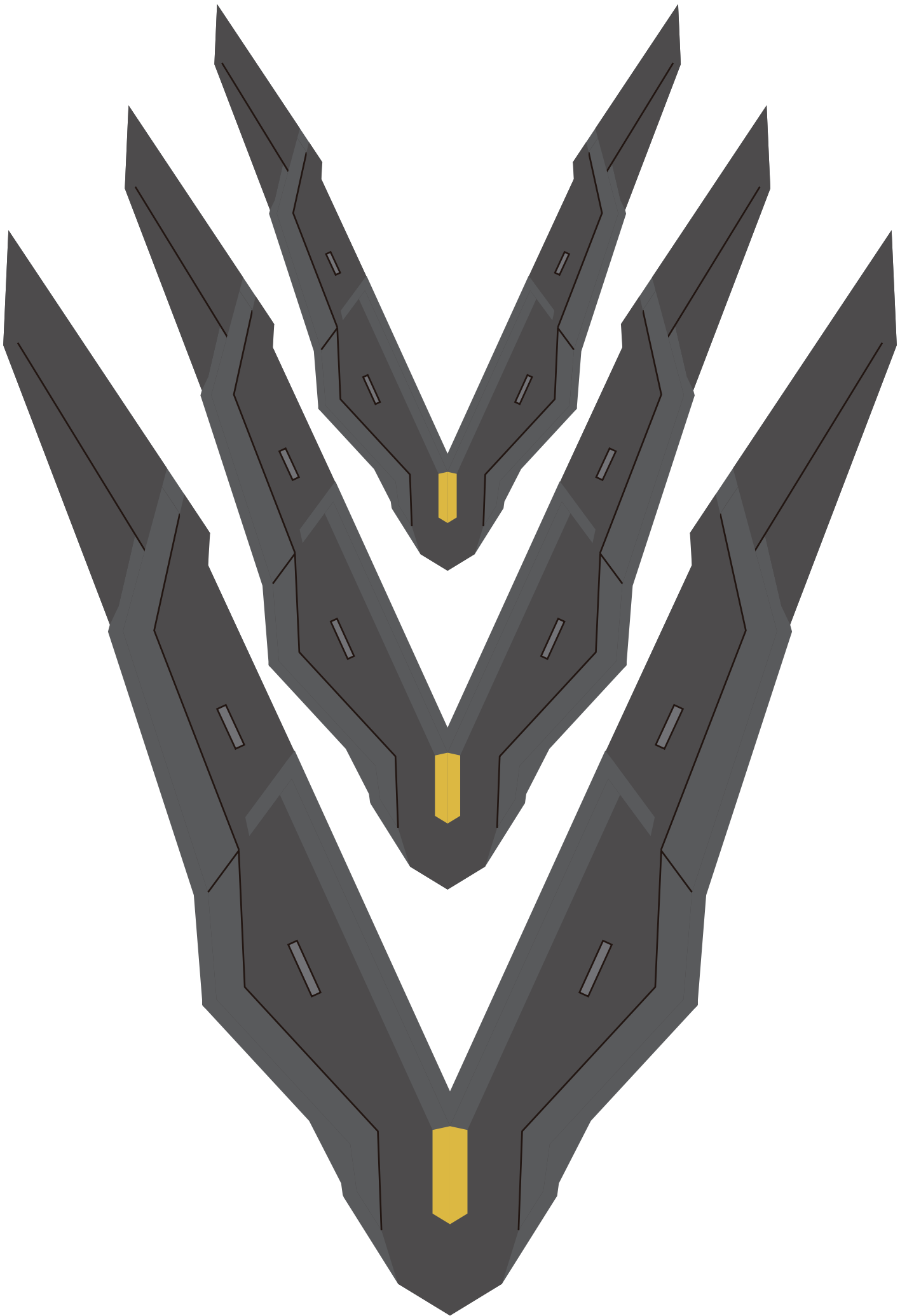

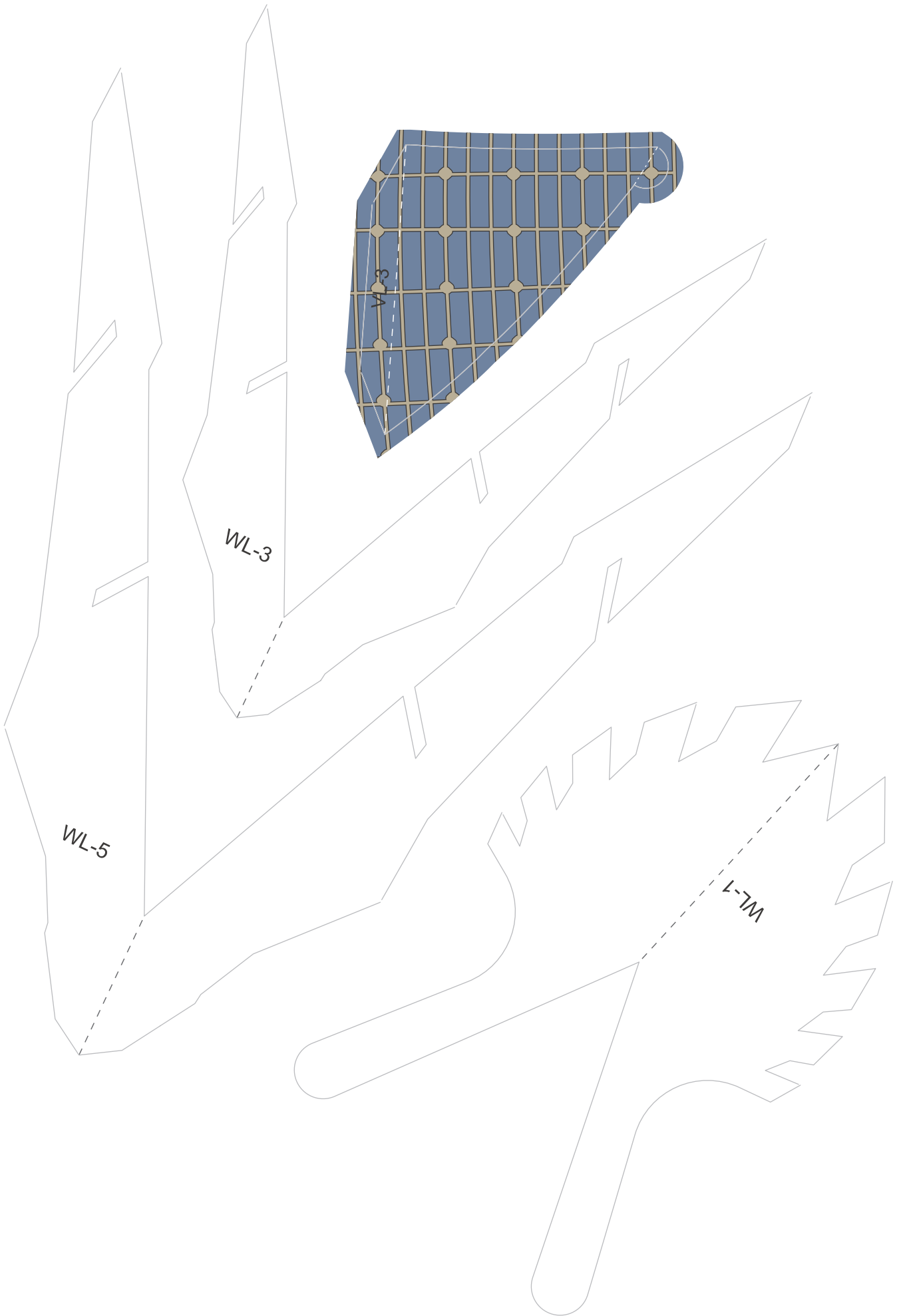

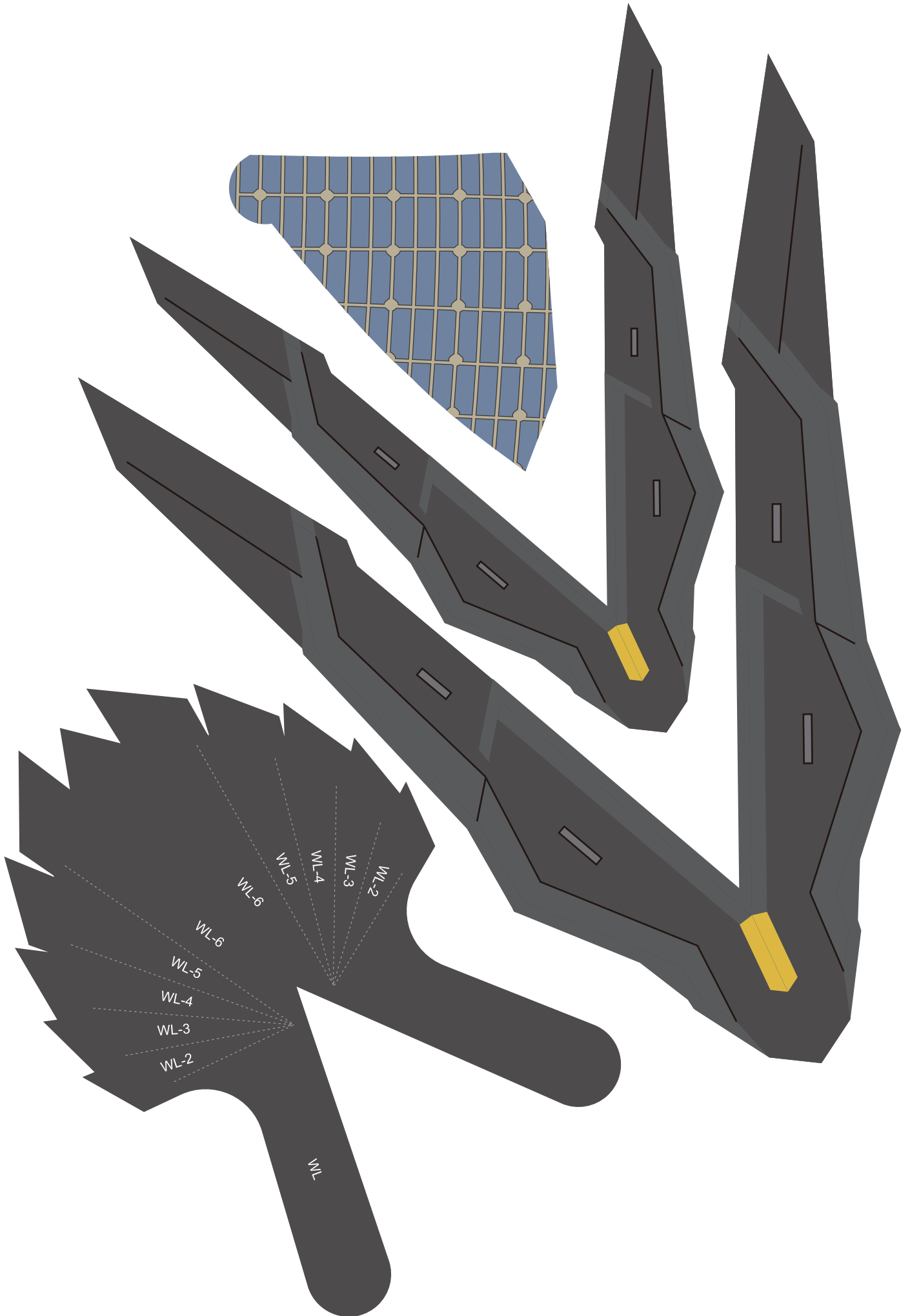

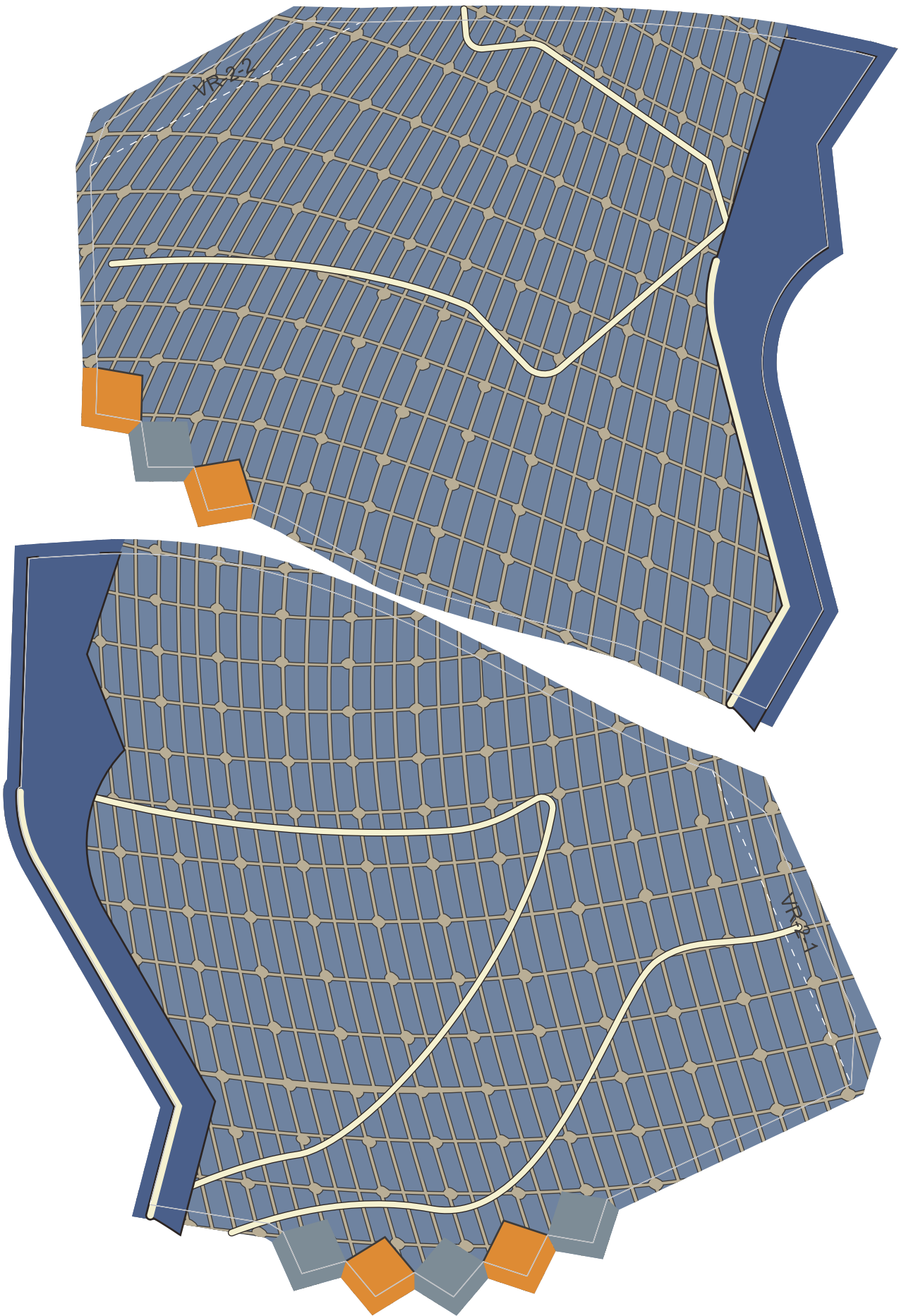

VR 2-2

VR 1-1

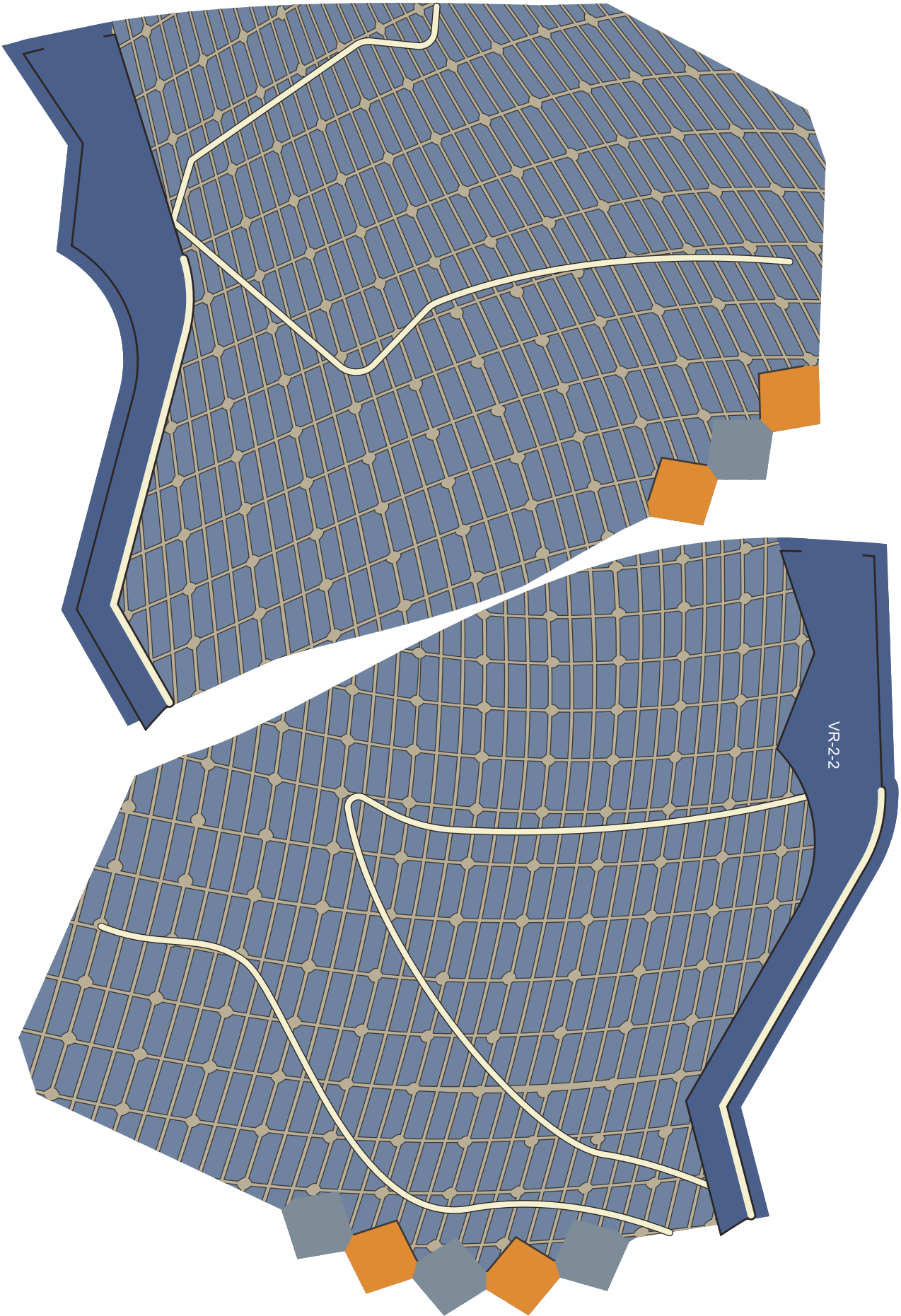

VR-2-2

